



CE

Operating instructions  
Retro-reflective sensor

UK

**O5P5xx**

11470786 / 00 06 / 2011

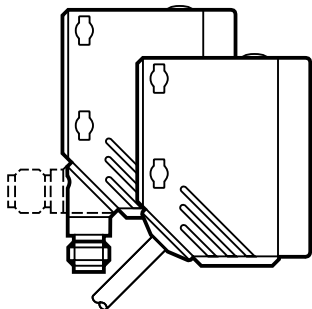

# 1 Preliminary note

## 1.1 Symbols used

- ▶ Instruction
- > Reaction, result
- [...] Designation of pushbuttons, buttons or indications
- Cross-reference



Important note

Non-compliance can result in malfunctions or interference.

## 2 Functions and features

In conjunction with a prismatic reflector or reflective tape the retro-reflective sensor detects objects and materials without contact and indicates their presence by a switching signal.

Range: (→ type label).

## 3 Installation

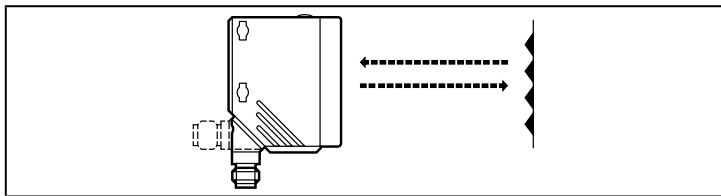

- ▶ Fit the prismatic reflector or the reflective tape behind the object to be detected.
- ▶ Align the retro-reflective sensor to it and secure it to a bracket.

Maximum range only with accurate alignment.

## 4 Operating and display elements

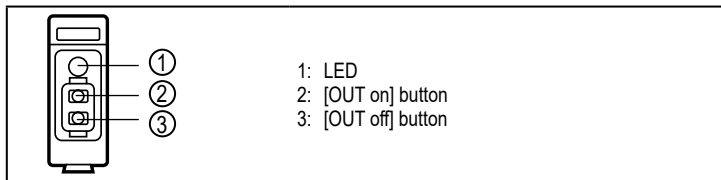

## 5 Electrical connection



The unit must be connected by a qualified electrician.

- ▶ The national and international regulations for the installation of electrical equipment must be adhered to.
- ▶ Ensure voltage supply to EN 50178.

▶ Disconnect power.

▶ Connect the unit as follows:

### Connector

p-switching

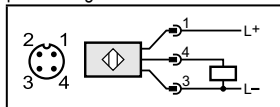

n-switching

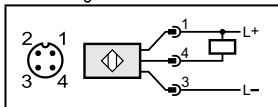

### Cable

p-switching

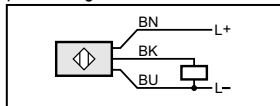

n-switching

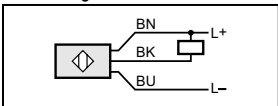



Core colours: BN = brown, BU = blue, BK = black

## 6 Settings

### 6.1 Sensitivity setting

The sensor is to switch when the object is detected

1	<p>▶ Position the object.</p>  <p>▶ Press [OUT on] for 2 s. &gt; The sensitivity is set to the object. The LED flashes.</p>
2	<p>▶ Remove the object.</p>  <p>▶ Press [OUT off]. &gt; The sensitivity is set without object. &gt; The LED goes out. The setting operation is completed.</p>

The sensor is not to switch when the object is detected

▶ Position the object (see figure 1) and press [OUT off].

▶ Remove the object (see figure 2) and press [OUT on].

The setting can also be carried out first without object and then with object.

### 6.2 Setting of maximum sensitivity

▶ Align the sensor so that no light is reflected.

The sensor is to switch when the object is detected

▶ First press [OUT on], then [OUT off].

The sensor is to switch when the object is not detected

▶ First press [OUT off], then [OUT on].

### 6.3 Setting unsuccessful

- > The LED flashes quickly, 8 Hz.
- > The sensor returns to the normal operating mode with unchanged values.

#### Possible causes

- Insufficient difference in measurements
- Max. programming time of 15 min. exceeded

### 6.4 Electronic lock

The unit can be locked electronically to prevent unauthorised setting. On delivery the unit is not locked.

UK

- ▶ Press [OUT on] and [OUT off] simultaneously for 10 s.
- > Acknowledgement is indicated by a change of the LED status.
- ▶ To unlock repeat this step.



## 7 Operation

- ▶ Check whether the unit operates correctly.
- > Display by LEDs.

## 8 Maintenance, repair, disposal

- ▶ Keep the lens of the sensor free from soiling.
- ▶ For cleaning do not use any solvents or cleaning agents which could damage the plastic parts.
- ▶ After use dispose of the unit in an environmentally friendly way in accordance with the applicable national regulations.

Faulty sensors must only be repaired by the manufacturer.

Technical data and further information at  
[www.ifm.com](http://www.ifm.com) → Select your country → Data sheet direct: