

ifm electronic



Operating instructions
AS-i module

ecomat300

AC2618

AC2619

UK

7390306/02 06/2012

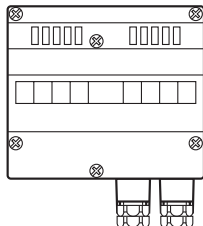

Contents

1 Preliminary note.....	3
2 Safety instructions	3
3 Functions and features	3
4 Addressing.....	4
4.1 Lower parts without addressing socket	4
4.2 Lower parts with addressing socket	4
5 Mounting.....	4
6 Electrical connection.....	4
6.1 Device supply	4
6.2 Wiring.....	5
6.3 Connection analogue module AC2618 (0...20 mA)	6
6.3.1 Connection of an actuator without separate voltage supply	6
6.3.2 Connection of an actuator with intrinsic supply	6
6.3.3 Connection of an actuator with separate 24 V supply	7
6.3.4 Electrical connection 0 V terminal	7
6.4 Connection analogue module AC2619 (0...10 V)	8
6.4.1 Connection of an actuator with intrinsic supply	8
6.4.2 Connection of an actuator with separate 24 V supply.	9
7 Parameter setting	9
8 Measuring range.....	9
8.1 Analogue module AC2618	9
8.2 Analogue module AC2619	10
8.3 Transmission time of the analogue values	10
9 Operation.....	10
10 Maintenance, repair and disposal.....	11
11 Technical data	11
12 Scale drawing	11

1 Preliminary note

- ▶ Instructions
- > Reaction, result



Important note

Non-compliance can result in malfunction or interference.



Information

Supplementary note.

2 Safety instructions

UK

- Please read the operating instructions prior to set-up of the device. Ensure that the product is suitable for your application without any restrictions.
- The unit conforms to the relevant regulations and EC directives.
- Improper or non-intended use may lead to malfunctions of the unit or to unwanted effects in your application.
- Installation, electrical connection, set-up, operation and maintenance of the unit must only be carried out by qualified personnel authorised by the machine operator.

3 Functions and features

The slave receives data via the AS-Interface and converts them into analogue output signals. The AS-i module operates as a slave with bidirectional data transfer in the AS-i network.

The data transfer from the host to the slave is asynchronous according to the AS-i profile S-7.3 and the AS-i specification V2.1.

- Current output 0..20 mA (AC2618) or voltage output 0..10 V (AC2619)
- AS-i profile S-7.3.5
- The connection of actuators is made via cage clamps
- Maximum number of modules per AS-i system: 31
- R_{\max} for current output 600 Ω ; R_{\min} for voltage output 3.3 k Ω
- Conversion time (digital - analogue) in the slave with two channels: < 1 ms
- Actuator supply from AS-i (max. 90 mA) or external 24 V PELV voltage source (black flat cable)

- Resolution 16 bits

4 Addressing

4.1 Lower parts without addressing socket

- ▶ Use the addressing unit AC1154 to assign a free address between 1 and 31. The address is set to 0 at the factory.

4.2 Lower parts with addressing socket

- ▶ When mounted and wired, address the device with the addressing cable (E70213) via the integrated addressing interface.



No addressing via the addressing socket while live.

5 Mounting

- ▶ Mount the device on a wired lower part of the AS-i network, tightening torque 0.8 Nm.

6 Electrical connection



The unit must be connected by a qualified electrician.

The national and international regulations for the installation of electrical equipment must be adhered to.

- ▶ Disconnect power.
- ▶ Connect the device to the AS-Interface via the standardised EMS (supply from AS-i) or the E-EMS (supply from an external 24 V PELV voltage source).



If a total of over 90 mA is needed for the actuator supply, the supply must be from an external 24 V PELV voltage source.



If the module is to be supplied from an external 24 V PELV source,

- ▶ mount an FC-E lower part (AC5003, AC5011).

6.1 Device supply

Select the type of supply via links inside the module.



To select the voltage supply, only change the position of the links when the module is disconnected.

- ▶ Switch off the module supply.
- ▶ Loosen the screws and remove the module cover.

The links for the supply selection are now freely accessible.

Place the links as follows

Supply from AS-i		Supply from an external 24 V PELV voltage source	
------------------	--	--	--

UK

6.2 Wiring

1	O+ actuator supply 2 +24 V
2	C2 analogue output current (AC2618) V2 analogue output voltage (AC2619)
3	O- actuator supply 2 0 V
4	COM2 analogue output 2 0 V
5	screen
6	screen
7	O+ actuator supply 1 +24 V
8	C1 analogue output current (AC2618) V1 analogue output voltage (AC2619)
9	O+ actuator supply 1 0 V
10	COM1 analogue output 1 0 V
11	FE functional earth
12	FE functional earth

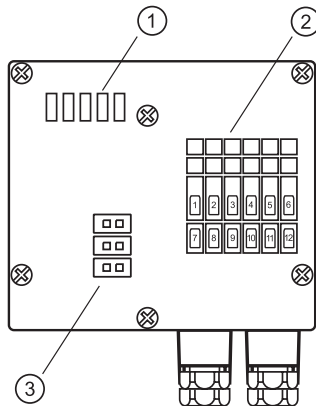

- 1: LEDs
- 2: Cage clamp terminal block
- 3: Jumpers

6.3 Connection analogue module AC2618 (0...20 mA)

6.3.1 Connection of an actuator without separate voltage supply

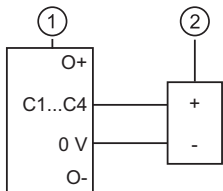

A 2-wire actuator is connected via the terminals C1/2...C4 and COM1/2. The terminals O+ and O- are not used with actuators without separate voltage supply.

- 1: Analogue module
- 2: Actuator without separate supply

6.3.2 Connection of an actuator with intrinsic supply

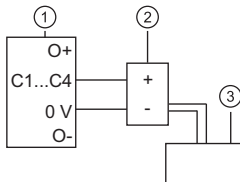

An actuator with intrinsic supply (e.g. an ampere meter) is connected via the terminals C1/2 and COM1/2. The terminals O+ and O- are not used with actuators with separate voltage supply.

- 1: Analogue module
- 2: Actuator with intrinsic supply
- 3: Supply PELV ungrounded

6.3.3 Connection of an actuator with separate 24 V supply

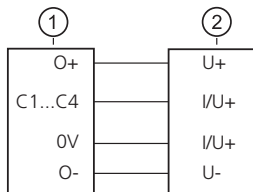

An actuator with separate supply is connected to the external 24 V via the terminals O+ and O-. The signal can be taken from the terminals C1/2 and COM1/2.

- 1: Analogue module
- 2: Actuator with separate supply

6.3.4 Electrical connection 0 V terminal

- ▶ Do not connect the 0 V terminals (analogue output 0 V) of the respective channels of the current output modules to each other.
- > This connection leads to faulty current signals.



The connection of the 0 V terminals (analogue output 0 V) results in a parallel connection of the resistances R1 and R2 (see drawing). This leads to faulty current signals.

Example

This problem can occur when a frequency converter is connected, i.e. the connection of the 0 V- terminal is established there (common-).



- ▶ Adhere to the documentation of the frequency converter.

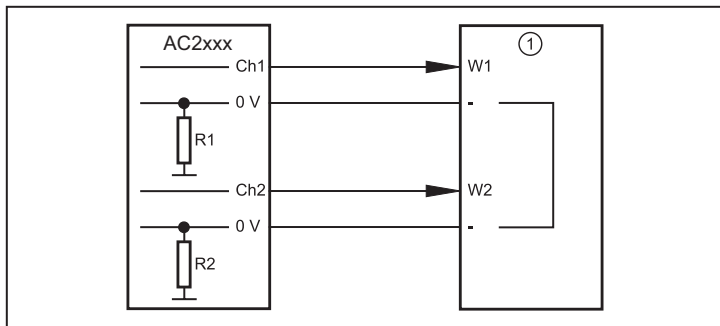

1: Frequency converter

► As a remedy, use two current output modules.

6.4 Connection analogue module AC2619 (0...10 V)

6.4.1 Connection of an actuator with intrinsic supply

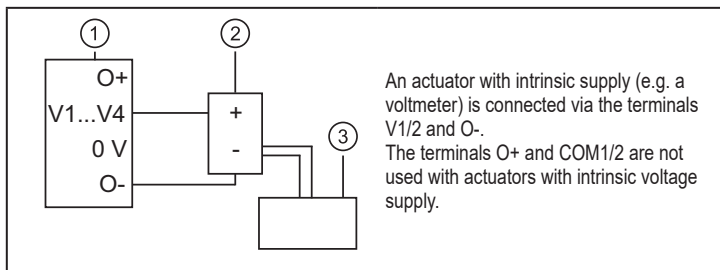

1: Analogue module

2: Actuator with intrinsic supply

3: Supply PELV ungrounded

6.4.2 Connection of an actuator with separate 24 V supply.

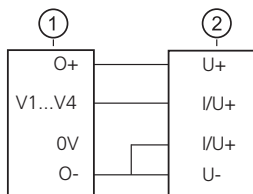

An actuator with separate supply is connected to the external 24 V via the terminals O+ and O-. The signal can be taken from the terminals V1/2 and COM1/2.

The terminals O- and COM1/2 must be connected to each other via a link.

- 1: Analogue module
2: Actuator with separate supply

7 Parameter setting

Parameter bit / Designation	Description
P0 / not used	1 reserved / 0 reserved
P1 / not used	1 reserved / 0 reserved
P2 / periphery fault	1 error indication active / 0 error indication inactive
P3 / not used	1 reserved / 0 reserved

8 Measuring range

- The measuring ranges, the states of the LEDs and their meaning are indicated in the following tables.

8.1 Analogue module AC2618

Range 0...20 mA	Units dec.	Units hex.	LEDs O1...O4 analogue	Description
0 mA	< 0000	< 0000	flash	outside range
0...20 mA	0000...20000	0000...4E20	on	nominal range
20.001... 23 mA	20001...23000	4E21...59D8	on	above nominal range
> 23 mA	> 23000	> 59D8	flash	overflow

8.2 Analogue module AC2619

Range 0...10 V	Units dec.	Units hex.	LEDs O1...O4 analogue	Description
> 0 V	< 0000	< 0000	flash	outside range
0 ...10 V	0000...10000	0000...2710	on	nominal range
10.001...11.5 V	10001...11500	2711...2CEC	on	above nominal range
> 11.5 V	> 11500	> 2CEC	flash	overflow

8.3 Transmission time of the analogue values

The transmission time of the analogue values depends on the conversion time of the digital signals into analogue signals in the AS-i module and on the transmission time via the AS-Interface.

The conversion time of the digital signals is approx. 1 ms.

The transmission time of the 2 16-bit values via the AS-interface ideally is 7 AS-i cycles per value. For a cycle time of 5 ms per AS-i cycle this results in a transmission time of $2 \times 7 \times 5 \text{ ms} = 70 \text{ ms}$ via the AS-Interface.

Thus the total transmission time for 2 analogue values ideally is 1 ms (conversion time) + 70 ms (transmission time) = 71 ms.

9 Operation

► Check the safe functioning of the unit.

Display by LEDs:

LED AS-i green lights	AS-i voltage supply OK
LED yellow (analogue 1) lights	Analogue signal in the nominal range
LED yellow (analogue 1) flashes	Analogue signal outside the nominal range
LED yellow (analogue 2) lights	Analogue signal in the measuring range
LED yellow (analogue 2) flashes	Analogue signal outside the measuring range
LED green (D/A power) lights	Supply voltage for the A/D converter present The LED reflects the status of the voltage from which the actuator is supplied. It depends on the selected link position.

LED FAULT red flashes	Periphery fault. A periphery fault is indicated if at least one of the analogue signals is outside the value range.
LED red (FAULT) lights	AS-i communication error

10 Maintenance, repair and disposal

The operation of the unit is maintenance-free. After use dispose of the unit in an environmentally friendly way in accordance with the applicable national regulations.

UK

11 Technical data

Technical data and further information at www.ifm.com.

12 Scale drawing

