

HF (13.56 MHz)  
 BIS M-4008-048-002-ST4  
 Kod artykułu: BIS017A

# BALLUFF

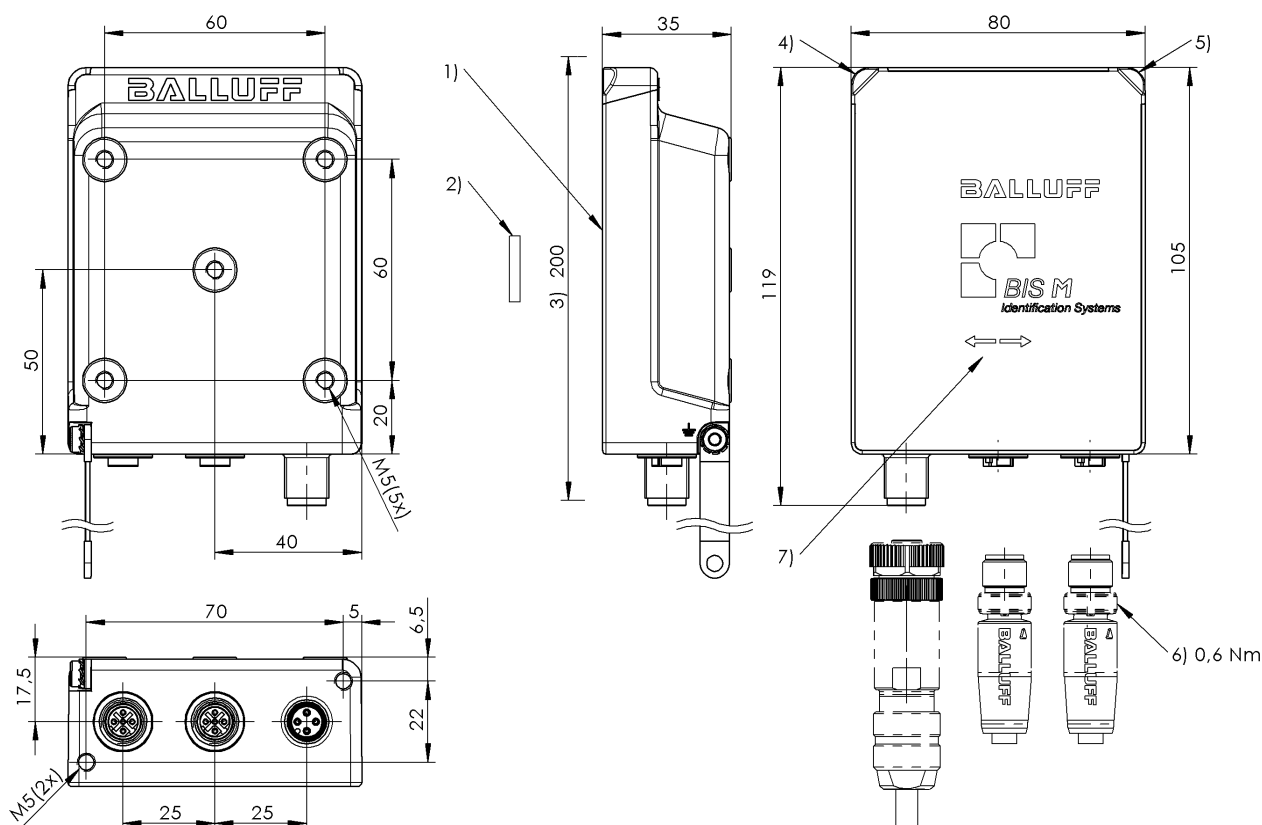

1) powierzchnia aktywna, 2) Nośnik danych, 3) Strefa wolna, 4) LED (Power), 5) LED (CP), 6) Moment dociągania, 7) Oś zapisu/odczytu



## Basic features

Dopuszczenie / Zgodność	CE UKCA WEEE
Kształt anteny	Pręt
Zasada działania	Urządzenie do zapisu/odczytu

## Display/Operation

Wskaźnik zadziałania	Zasilanie, zielona dioda LED CP (nośnik danych obecny), żółta dioda LED Link Port 1, LED zielona System Failure Status, czerwona dioda LED Status błędu sieci BUS. dioda czerwona LED Aktywny Port 2, żółta dioda LED Aktywny Port 1, żółta dioda LED Link Port 2, LED zielona
----------------------	---

## Electrical connection

Przyłącze (COM 1)	Port 1: M12x1-Żeński, 4-stykowe, D-kodowany
Przyłącze (COM 2)	Port 2: M12x1-Żeński, 4-stykowe, D-kodowany
Przyłącze (napięcie zasilania IN)	M12x1-Męski, 4-stykowe, A-kodowany

## Electrical data

Maks. pobór prądu przy 24V DC	150 mA
Napięcie robocze $U_b$	19.2...28.8 VDC LPS klasa 2
Napięcie znamionowe	24 VDC
Tętnienia resztkowe maks.	10 %

HF (13.56 MHz)  
**BIS M-4008-048-002-ST4**  
**Kod artykułu: BIS017A**

**BALLUFF**

**Environmental conditions**

Area of operation	Indoor
EN 60068-2-27 szok	tak
EN 60068-2-32 Swobodny upadek	tak
EN 60068-2-6 wibracja	tak
Stopień ochrony	IP67, z łącznikiem wtykowym
Stopień zanieczyszczenia	2
Temperatura otoczenia	0...70 °C
Temperatura przechowywania	-20...85 °C
Wysokość maks.	2000 m
Względna wilgotność powietrza	0...90 %, bez skraplania

**Functional Characteristics**

Obsługiwane typy nośników danych	DIN ISO 15693 DIN ISO 15693 (High Memory)
----------------------------------	---

**Functional safety**

MTTF (40 °C)	68 a
--------------	------

**Interface**

Interfejs	Profinet I/O (IRT) Profinet I/O (IRT) 2-Port Switch
-----------	--

**Material**

Materiał obudowy	Cynk, Odlew ciśnieniowy
------------------	-------------------------

**Mechanical data**

Masa	490.00 g
Montaż	bez metalu (wolna strefa) na metalu równo z płaszczyzną aktywną w metalu
Wymiary	80 x 35 x 119 mm

**Remarks**

Tylko do nośnika danych wg normy ISO 15693.

Przy pierwszej instalacji zamówić: akcesoria patrz [www.balluff.com](http://www.balluff.com)

Przy instalacji należy przestrzegać norm technicznych i przepisów danego kraju.

Jeśli nie podano inaczej, wartości dot. warunków znamionowych.

This device is intended to be supplied by a UL-listed or CSA-certified power supply unit with "Class 2" or LPS power source.

The product is maintenance-free.

The device can be cleaned with a slightly damp cloth.

The devices must be installed permanently.

Check the function of the device and all associated components regularly by visual and functional testing. - In the event of malfunctions, take the device out of operation. - Secure the system against unauthorized use. - Check fastening and tighten if necessary. 1 Determine suitable mounting position. 2. Fasten the device with suitable mounting material.

Dalsze informacje dot. MTTF lub B10d patrz Certyfikat MTTF / B10d

Podawanie wartości MTTF- / B10d nie stanowi wiążącego zapewnienia o właściwościach i/lub żywotności produktu; są to jedynie wartości ustalone doświadczalnie, bez charakteru zobowiązującego. Na podstawie tych wartości nie przedłuża się również okresu przedawnienia roszczeń z tytułu wad ani nie wpływa to na ten okres w jakiegokolwiek innej formie.

**Connector Drawings**

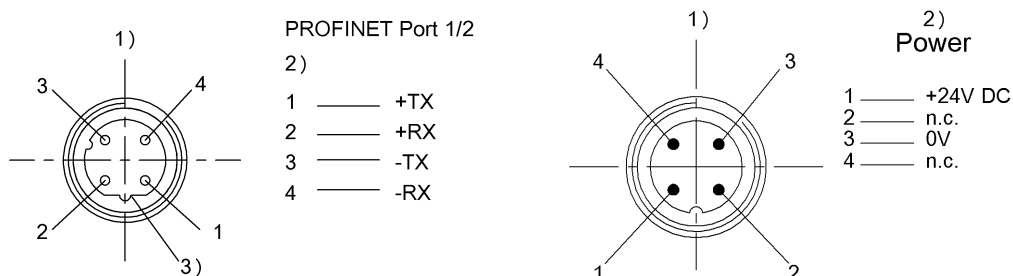

- 1) Widok w kierunku wtyku
- 2) Gniazdo 4 -styk./ funkcja
- 3) Kodowanie D

- 1) Widok w kierunku wtyku
- 2) Wtyczka 4 -styk./ funkcja

HF (13.56 MHz)  
BIS M-4008-048-002-ST4  
Kod artykułu: BIS017A

**BALLUFF**

Help Views

**BIS M-4008-002**

	BIS M-150-02/A	BIS M-151-02/A	BIS M-150-02/A	BIS M-151-02/A
passende Datenträger Appropriate data carriers				
Freizone Datenträger in mm ( a ) Data carrier clear zone in mm	>200 >200	>200 >200	>200 >200	>200 >200
Freizone Datenträger in mm ( b ) Data carrier clear zone in mm	>200 >200	>200 >200	>200 >200	>200 >200
Datenträger Metall-Montagefläche 40x22 Data carrier metal mounting surface 40x22	0-65 0-65	0-65 0-65	0-60 0-60	0-45 0-45
Datenträger Metall-Montagefläche ≥ 200x200 Data carrier metal mounting surface ≥ 200x200	0-65 0-65	0-65 0-65	0-60 0-60	0-45 0-45
Schreibabstand in mm Write distance in mm	0-65 0-65	0-65 0-65	0-60 0-60	0-45 0-45
Lesabstand in mm Read distance in mm	0-65 0-65	0-65 0-65	0-60 0-60	0-45 0-45
Versatz in mm bei Abstand von	X Y	Y X	X Y	Y X
	0 ±70 ±30	±70 ±30	±65 ±30	±50 ±25
	5 ±70 ±30	±70 ±30	±65 ±30	±50 ±25
	10 ±70 ±30	±70 ±30	±65 ±30	±50 ±25
	15 ±70 ±30	±70 ±30	±65 ±30	±50 ±25
	20 ±70 ±30	±70 ±30	±65 ±30	±50 ±25
	25 ±65 ±25	±65 ±25	±60 ±25	±40 ±20
	30 ±65 ±25	±65 ±25	±60 ±25	±40 ±20
	35 ±65 ±25	±65 ±25	±60 ±25	±40 ±20
	40 ±65 ±25	±65 ±25	±60 ±25	±30 ±15
	45 ±40 ±20	±40 ±20	±40 ±20	±5 ±5
	50 ±40 ±20	±40 ±20	±40 ±20	
	55 ±40 ±20	±40 ±20	±40 ±20	
	60 ±40 ±20	±40 ±20	±20 ±10	
	65 ±20 ±10	±20 ±10		
	70			
	75			
	80			

Offset in mm  
at distance

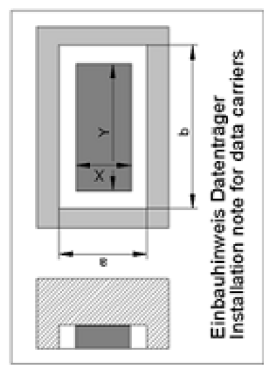

**BIS M-4008-002**

	BIS M-152-03/A					
passende Datenträger						
Appropriate data carriers						
Freizone Datenträger in mm ( a )	>200	>200				
Data carrier clear zone in mm						
Freizone Datenträger in mm ( b )	>200	>200				
Data carrier clear zone in mm						
Freizone Datenträger in mm ( c )	>50	>50				
Data carrier clear zone in mm						
Schreibabstand in mm	0-35	0-35				
Write distance in mm						
Leseabstand in mm	0-35	0-35				
Read distance in mm						
Versatz in mm	X	Y				
bei Abstand von	0	±44	±22			
	5	±44	±22			
	10	±44	±22			
	15	±40	±20			
	20	±40	±20			
	25	±32	±18			
	30	±32	±18			
	35	±10	±3			
	40					
	45					
	50					
	55					
	60					
	80					
	95					
	100					
	110					

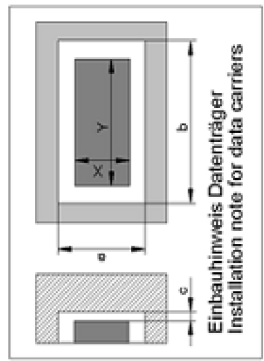

**BIS M-4008-002**

	BIS M-153-02/A	BIS M-153-02/A	BIS M-153-1x/A	BIS M-153-20/A	BIS M-153-20/A
passende Datenträger Appropriate data carriers					
Freizone Datenträger in mm ( a ) Data carrier clear zone in mm	>240 >240	>240 >240	>240 >240	>240 >240	>240 >240
Freizone Datenträger in mm ( b ) Data carrier clear zone in mm	>480 >480	>480 >480	>480 >480	>480 >480	>480 >480
Schreibabstand in mm Write distance in mm	>50 >50	>50 >50	>50 >50	>50 >50	>50 >50
Lesebestand in mm Read distance in mm	0-100 0-100	0-100 0-100	0-55 0-55	5-75 5-75	5-75 5-75
Versatz in mm bei Abstand von Offset in mm at distance	0-100 0-100 X Y	0-100 0-100 X Y	0-55 0-55 X Y	5-75 5-75 X Y	5-75 5-75 X Y
	0 ±100 ±40	0 ±100 ±40	±65 ±30	±80 ±35	±80 ±35
	5 ±100 ±40	5 ±100 ±40	±65 ±30	±80 ±35	±80 ±35
	10 ±100 ±40	10 ±100 ±40	±65 ±30	±80 ±35	±80 ±35
	20 ±100 ±40	20 ±100 ±40	±65 ±30	±80 ±35	±80 ±35
	25 ±100 ±40	25 ±100 ±40	±60 ±25	±70 ±30	±70 ±30
	30 ±100 ±40	30 ±100 ±40	±60 ±25	±70 ±30	±70 ±30
	40 ±100 ±40	40 ±100 ±40	±60 ±25	±70 ±30	±70 ±30
	50 ±80 ±35	50 ±80 ±35	±30 ±20	±70 ±30	±70 ±30
	55 ±80 ±35	55 ±80 ±35	±20 ±10	±40 ±25	±40 ±25
	60 ±80 ±35	60 ±80 ±35		±40 ±25	±40 ±25
	70 ±80 ±35	70 ±80 ±35		±40 ±25	±40 ±25
	75 ±80 ±35	75 ±80 ±35		±15 ±10	±15 ±10
	80 ±80 ±35	80 ±80 ±35			
	95 ±55 ±25	95 ±55 ±25			
	100 ±30 ±10	100 ±30 ±10			
	110				
	120				

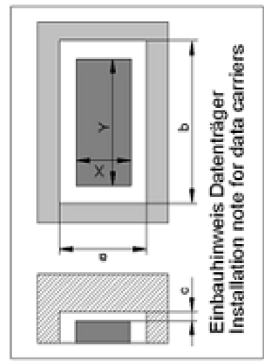

**BIS M-4008-002**

	BIS M-155-1x/A	BIS M-155-1x/A	BIS M-156-1x/A	BIS M-156-1x/A	BIS M-156-1x/A
passende Datenträger Appropriate data carriers					
Freizone Datenträger in mm ( a ) Data carrier clear zone in mm	>200 >200	>200 >200	>200 >200	>200 >200	>200 >200
Freizone Datenträger in mm ( b ) Data carrier clear zone in mm	>200 >200	>200 >200	>200 >200	>200 >200	>200 >200
Datenträger Metall-Montagefläche 40x22 Data carrier metal mounting surface 40x22	0-42 0-42	0-42 0-42	0-42 0-42	0-42 0-42	0-42 0-42
Datenträger Metall-Montagefläche ≥ 200x200 Data carrier metal mounting surface ≥ 200x200		0-42 0-42	0-42 0-42	0-42 0-42	0-42 0-42
Schreibabstand in mm Write distance in mm	0-42 0-42	0-42 0-42	0-42 0-42	0-42 0-42	0-42 0-42
Leseabstand in mm Read distance in mm	0-42 0-42	0-42 0-42	0-42 0-42	0-42 0-42	0-42 0-42
Versatz in mm bei Abstand von Offset in mm at distance	X Y ±45 ±25 ±45 ±25 ±45 ±25 ±45 ±25 ±45 ±25 ±30 ±18 ±30 ±18 ±30 ±18 ±20 ±10 ±10 ±5	X Y ±45 ±25 ±45 ±25 ±45 ±25 ±45 ±25 ±45 ±25 ±30 ±18 ±30 ±18 ±30 ±18 ±20 ±10 ±10 ±5	X Y ±45 ±25 ±45 ±25 ±45 ±25 ±45 ±25 ±45 ±25 ±30 ±18 ±30 ±18 ±30 ±18 ±20 ±10 ±10 ±5	X Y ±45 ±25 ±45 ±25 ±45 ±25 ±45 ±25 ±45 ±25 ±30 ±18 ±30 ±18 ±30 ±18 ±20 ±10 ±10 ±5	X Y ±45 ±25 ±45 ±25 ±45 ±25 ±45 ±25 ±45 ±25 ±30 ±18 ±30 ±18 ±30 ±18 ±20 ±10 ±10 ±5
	0	5	10	15	20
	25	30	35	40	42
	45	50	55	60	65
	70	75			

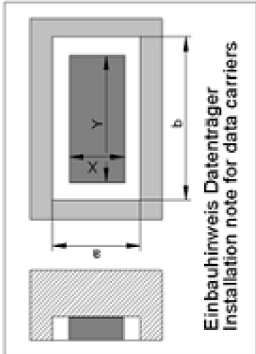

**BIS M-4008-002**

	BIS M-155-20/A	BIS M-155-20/A	BIS M-156-20/A	BIS M-156-20/A
passende Datenträger Appropriate data carriers				
Freizone Datenträger in mm ( a ) Data carrier clear zone in mm	>200 >200	>200 >200	>200 >200	>200 >200
Freizone Datenträger in mm ( b ) Data carrier clear zone in mm	>200 >200	>200 >200	>200 >200	>200 >200
Datenträger Metall-Montagefläche 40x22 Data carrier metal mounting surface 40x22	0-68 0-68	0-68 0-68	0-68 0-68	0-68 0-68
Datenträger Metall-Montagefläche ≥ 200x200 Data carrier metal mounting surface ≥ 200x200		0-68 0-68		0-58 0-58
Schreibabstand in mm Write distance in mm	0-68 0-68	0-68 0-68	0-68 0-68	0-58 0-58
Leseabstand in mm Read distance in mm	0-68 0-68	0-68 0-68	0-68 0-68	0-58 0-58
Versatz in mm bei Abstand von Offset in mm at distance	X Y 0 ±75 ±32 5 ±75 ±32 10 ±75 ±32 15 ±75 ±32 20 ±75 ±32 25 ±70 ±28 30 ±70 ±28 35 ±70 ±28 40 ±70 ±28 45 ±50 ±25 50 ±50 ±25 55 ±50 ±25 58 ±50 ±25 65 ±50 ±25 68 ±20 ±10 75 80	X Y ±75 ±32 ±75 ±32 ±75 ±32 ±75 ±32 ±75 ±32 ±70 ±28 ±70 ±28 ±70 ±28 ±70 ±28 ±50 ±25 ±50 ±25 ±50 ±25 ±50 ±25 ±50 ±25 ±20 ±10	X Y ±75 ±32 ±75 ±32 ±75 ±32 ±75 ±32 ±75 ±32 ±70 ±28 ±70 ±28 ±70 ±28 ±70 ±28 ±50 ±25 ±50 ±25 ±50 ±25 ±50 ±25 ±50 ±25 ±20 ±10	Y X ±60 ±28 ±60 ±28 ±60 ±28 ±60 ±28 ±60 ±28 ±55 ±25 ±55 ±25 ±55 ±25 ±35 ±18 ±35 ±18 ±35 ±18 ±15 ±5

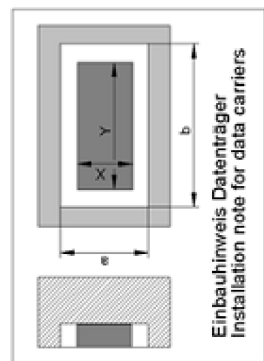



**BIS M-4008-002**

	BIS M-191-02/A	BIS M-191-02/A			
passende Datenträger Appropriate data carriers					
Freizone Datenträger in mm ( <b>a</b> ) Data carrier clear zone in mm	>27	>27			
Freizone Datenträger in mm ( <b>b</b> ) Data carrier clear zone in mm	>27	>27			
Datenträger auf Metall-Montagefläche Data carrier on metal mounting surface	0-30	0-30			
Montage Metallfrei Mounting non-metal	0-55	0-55			
Schreibabstand in mm Write distance in mm	0-55	0-55			
Lesabstand in mm Read distance in mm	0-55	0-55			
Versatz in mm bei Abstand von Offset in mm at distance	X 0 5 10 15 20 25 30 35 40 45 50 55 60 65 70 75	Y ±28 ±28 ±28 ±28 ±28 ±25 ±25 ±25 ±25 ±20 ±20 ±5 ±5 ±5 ±5 ±5	X 0-30 ±44 ±44 ±44 ±38 ±38 ±25 ±8	Y 0-30 ±24 ±24 ±24 ±21 ±21 ±15 ±5	

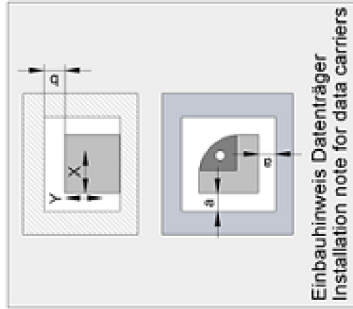

Einbauhinweis Datenträger  
 Installation note for data carriers