



Read head WCS3B-LS221H-OM

- For outdoor use
- Non-contact, absolute position encoder
- Extended temperature range
- Automatic detection of dirt accumulation
- RS-485 interface
- Freely selectable cable outlet due to rotating insert

Read head, RS-485 interface, with RS-485 termination resistor



Dimensions

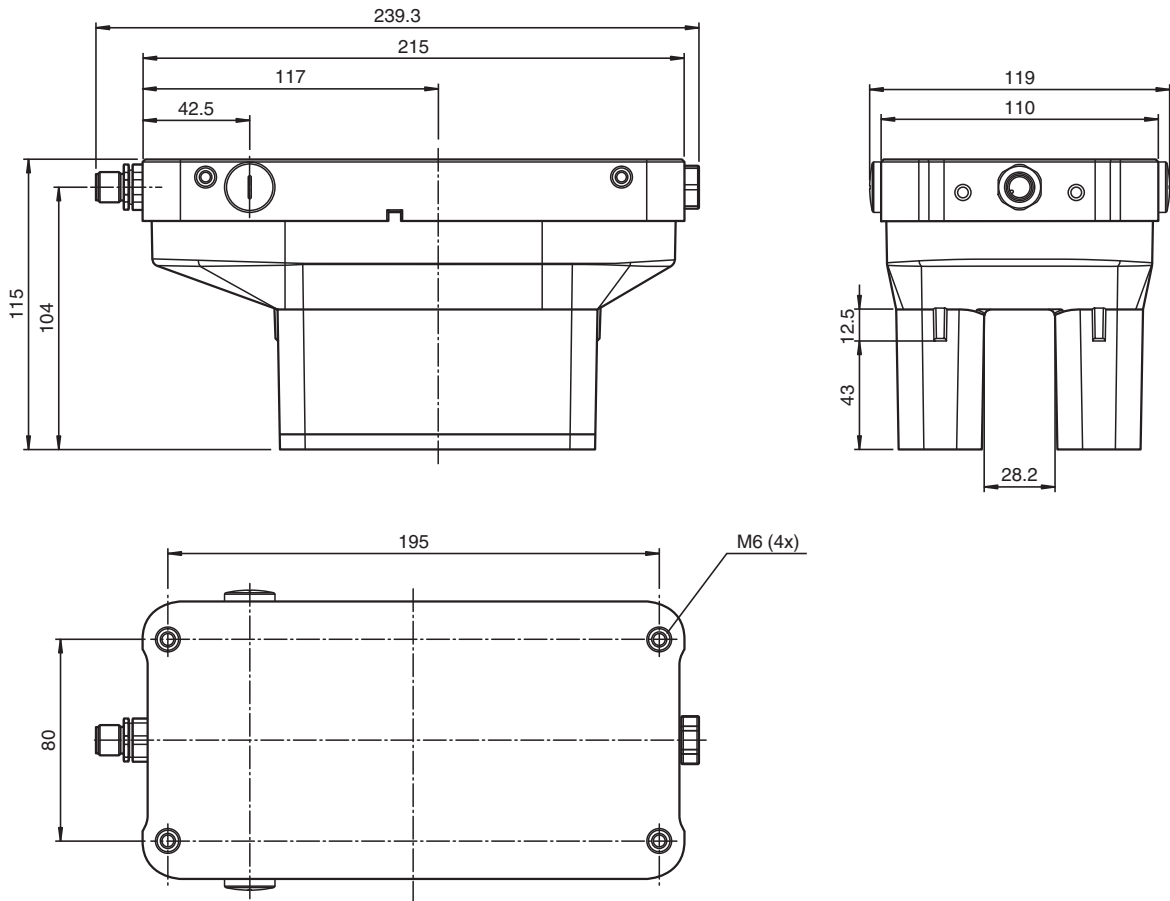

Technical Data

General specifications

Passage speed	v	≤ 12.5 m/s
Measuring range		max. 314.5 m

Release date: 2020-10-08 Date of issue: 2020-10-08 Filename: 199290-0044_eng.pdf

Refer to "General Notes Relating to Pepperl+Fuchs Product Information".

Pepperl+Fuchs Group
www.pepperl-fuchs.com

USA: +1 330 486 0001
fa-info@us.pepperl-fuchs.com

Germany: +49 621 776 1111
fa-info@de.pepperl-fuchs.com

Singapore: +65 6779 9091
fa-info@sg.pepperl-fuchs.com

PF PEPPERL+FUCHS

Technical Data

Free tolerances to code rail		horizontal: 28 mm (± 14 mm) vertical: 25.5 mm (+11.5 mm/-14 mm)
Resolution		± 0.4 mm (1,250 positions/m)
Functional safety related parameters		
MTTF _d		60 a
Mission Time (T _M)		10 a
Diagnostic Coverage (DC)		0 %
Indicators/operating means		
Operation indicator		LED green: power on
Data flow indicator		LED yellow: data communication active
Error indicator		LED red flashing: read head outside of code rail solid on: internal diagnostic test failed
Electrical specifications		
Operating voltage	U _B	10 ... 30 V DC
Power consumption	P ₀	11 VA at 24 V DC
Interface		
Interface type		RS 485 interface
Data output code		binary code
Protocol		1 , 2
Transfer rate		62.5 kBit/s
Address		0
Termination		with RS 485 termination
Standard conformity		
Emitted interference		DIN EN 61000-6-4 , DIN EN 12015
Noise immunity		DIN EN 61000-6-2 , DIN EN 12016
Shock resistance		DIN EN 60068-2-27, half sine 30 g, 18 ms
Vibration resistance		DIN EN 60068-2-6, sine, 5 g, 10 - 2000 Hz, 10 cycles
Approvals and certificates		
CSA approval		cCSAus Certified, General Purpose Class 2 power source
CCC approval		CCC approval / marking not required for products rated ≤36 V
Ambient conditions		
Operating temperature		-40 ... 60 °C (-40 ... 140 °F)
Storage temperature		-40 ... 85 °C (-40 ... 185 °F)
Mechanical specifications		
Connection type		5-pin, M12 x 1 connector
Degree of protection		IP67 / IP69
Material		
Housing		PET , PC (Polycarbonate)
Mass		1000 g
Note		The reader must not be operated without the protective housing!

Release date: 2020-10-08 Date of issue: 2020-10-08 Filename: 199290-0044_eng.pdf

Refer to "General Notes Relating to Pepperl+Fuchs Product Information".

Pepperl+Fuchs Group
www.pepperl-fuchs.com

USA: +1 330 486 0001
fa-info@us.pepperl-fuchs.com

Germany: +49 621 776 1111
fa-info@de.pepperl-fuchs.com



Singapore: +65 6779 9091
fa-info@sg.pepperl-fuchs.com

 PEPPERL+FUCHS

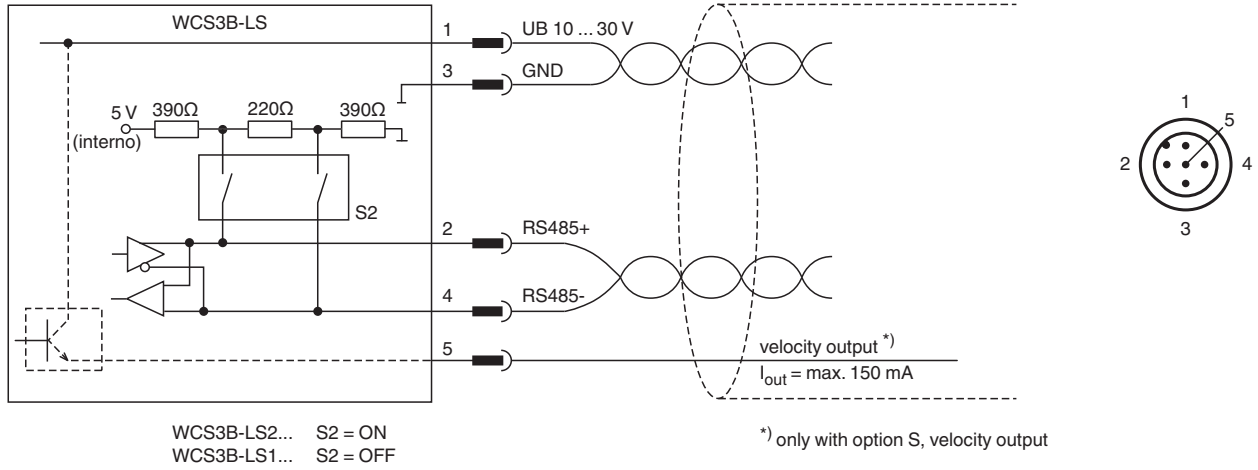
Connection



Accessories

	WCS3B-OBP	Stopping plugs For WCS3B-OP* housing
	WCS3B-OPC	Outdoor protective cover for WCS3B reader
	WCS3B-OPH	Outdoor protective housing for reader WCS3B

Release date: 2020-10-08 Date of issue: 2020-10-08 Filename: 199290-0044_eng.pdf