



Female connector V23-19-W-3M-PUR

- Sturdy design
- Plastic-coated
- Oil resistant

Female cordset, M23, 19-pin, PUR cable



Dimensions

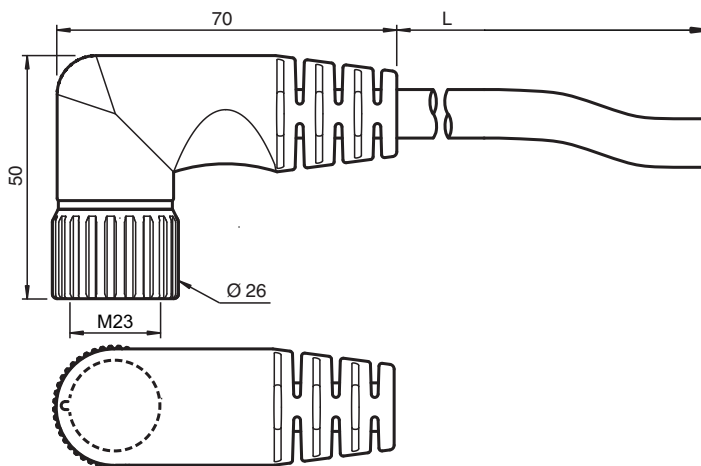

Technical Data

General specifications

Connector 1	
Connection	socket
Construction type	M23
Style	right angle
Locking	screw connection
Number of pins	19
Coding	A-coded
Connector 2	
Connection	cable end

Electrical specifications

Operating voltage	U_B	max. 48 V AC / 60 V DC
Operating current	I_B	12 A

Ambient conditions

Ambient temperature	
Plug connector	-40 ... 125 °C (-40 ... 257 °F)
Cable, fixed	-30 ... 70 °C (-22 ... 158 °F)

Release date: 2020-10-07 Date of issue: 2020-10-07 Filename: 200675_eng.pdf

Refer to "General Notes Relating to Pepperl+Fuchs Product Information".

Technical Data

Cable, flexing	-5 ... 70 °C (23 ... 158 °F)	
Pollution degree	2	
Mechanical specifications		
Plug connector		
Mating cycles	50	
Degree of protection	IP68	
Cable		
Sheath diameter	Ø 11.6 mm	
Sheath color	black	
Cores	16 x 0.5 mm ² and 3 x 1 mm ²	
Length	L	3 m
Material		
Plug connector		
Body	PUR	
Seal	FPM	
Contact surface	Au	
Cable		
Sheathing	PUR	
Core insulation	PVC	

Connection

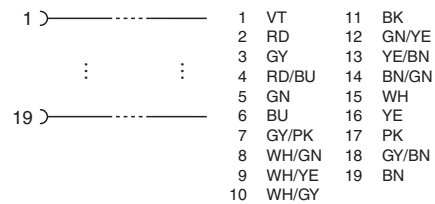
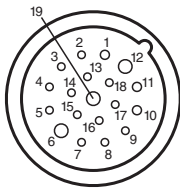

Release date: 2020-10-07 Date of issue: 2020-10-07 Filename: 200675_eng.pdf