



Model Number

V1S-WV4A-2M-PP-H1

Single-ended male cordset, M12, V4A stainless steel, hygienic design, 4-pin, PP cable

Features

- Suitable for applications involving contact with products in the food and beverage industry
- Certified by ECOLAB
- Resistant to all common acid and alkaline cleaning products and disinfectants
- Degree of protection IP67 / IP68 / IP69
- Suitable for drag chains
- Halogen-free (PVC-free)
- Materials used compliant with FDA
- Hygienic design in accordance with EHEDG

Accessories

MH V1-SCREWDRIVER
torque screwdriver (0.6 Nm)

MH V1-BIT M12-W14-HEX
Plug-in attachment for M12 with hex stainless steel knurled nut

Dimensions

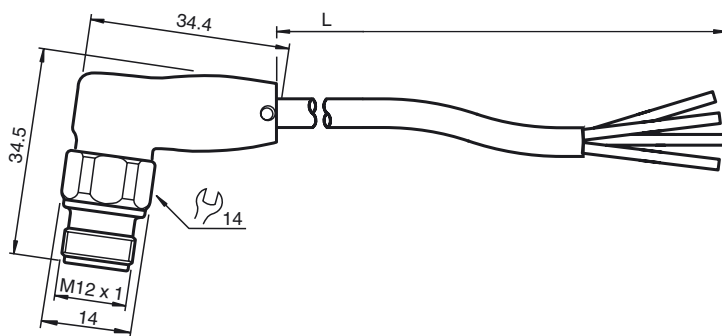

Technical data

General specifications

Number of pins	4
Connection 1	Male connector
Construction type 1	right angle
Threading 1	M12
Connection 2	cable end

Electrical specifications

Operating voltage	U_B	max. 250 V AC/DC
Operating current	I_B	max. 4 A

Ambient conditions

Ambient temperature	cable, flexing: -25 ... 105 °C (-13 ... 221 °F) cable, fixed: -40 ... 105 °C (-40 ... 221 °F)
---------------------	--

Pollution degree	3
------------------	---

Mechanical specifications

Contact elements	spring-loaded contact socket
Pin diameter	1 mm
Degree of protection	IP67 / IP68 / IP69
Material	
Contacts	CuSn
Contact surface	Ni/Au
Body	PP
Cable	PP-EPDM
Slotted nut	stainless steel V4A
Seal	FKM
Core insulation	PP
Temperature resistance	Cold bending-resistant and cold impact-resistant up to -40 °C (-40 °F)

Cable	extra-fine wire, flexible
Sheath diameter	Ø 4.7 mm
Bending radius	> 10 x cable diameter, moving > 5 x cable diameter, fixed
Color	grey
Cores	4 x 0.34 mm ²
Conductor construction	42 x 0.1 mm Ø
Length	L 2 m
Drag chain suitability	
Drag chain cycles	≥ 4000000
Motion velocity	≤ 3 m/s
Traverse distance	10 m
Acceleration	≤ 10 m/s ²
Torsion cycles	≥ 4000000
Torsional stress	± 270 °/m
Tightening torque, cable gland	0.4 ... 0.6 Nm
Mating cycles	≥ 100

Electrical connection



Compliance with standards and directives

Standard conformity	
Degree of protection	EN 60529
Standards	IEC 61076-2-101
Halogen-free	IEC 60754-1
Temperature resistance	DIN EN 60811-1-4
Material	FDA-compliant in accordance with FDA 21 CFR 177.2600

Release date: 2019-04-24 15:29 Date of issue: 2019-05-02 295188_eng.xml