



## Connection cable V1-W-E2-5M-PVC-V1-W

- Built-in LED, as operating and function indicator
- Degree of protection IP67 / IP68 / IP69
- Knurled nut suitable for tool assembly
- Immunity to vibration, with mechanical latching

Cordset M12 socket angled A-coded LED 3-pin to M12 plug angled A-coded 3-pin, PVC cable grey



### Dimensions

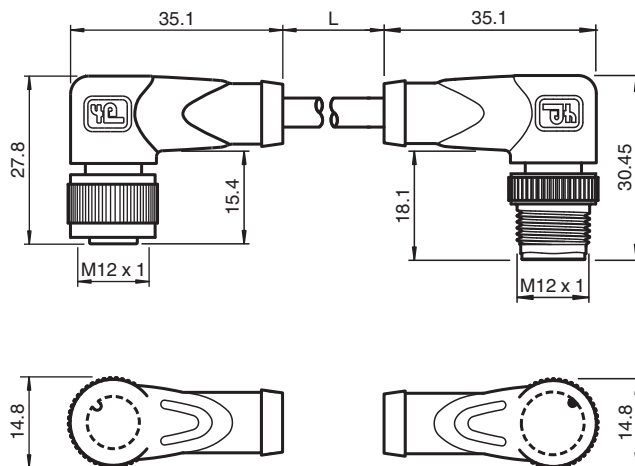

### Technical Data

#### General specifications

<b>Connector 1</b>	
Connection	socket
Construction type	M12
Style	angled
Locking	screw connection
Number of pins	3
Coding	A-coded
<b>Connector 2</b>	
Connection	plug
Construction type	M12
Style	angled
Locking	screw connection
Number of pins	3
Coding	A-coded
<b>Indicators/operating means</b>	
LED green	Operating display

Release date: 2021-04-05 Date of issue: 2021-04-05 Filename: 118365\_eng.pdf

Refer to "General Notes Relating to Pepperl+Fuchs Product Information".

Pepperl+Fuchs Group  
www.pepperl-fuchs.com

USA: +1 330 486 0001  
fa-info@us.pepperl-fuchs.com

Germany: +49 621 776 1111  
fa-info@de.pepperl-fuchs.com

Singapore: +65 6779 9091  
fa-info@sg.pepperl-fuchs.com

 PEPPERL+FUCHS

## Technical Data





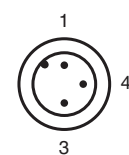
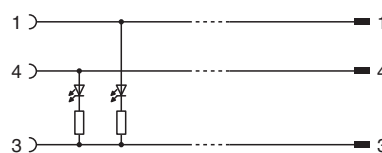
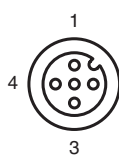

LED yellow	Functional display pin 4	
<b>Electrical specifications</b>		
Operating voltage	U <sub>B</sub>	max. 24 V DC -20 % / +25 %
Operating current	I <sub>B</sub>	max. 4 A
<b>Conformity</b>		
Degree of protection	EN 60529	
Plug connection	connector M12 x 1 : IEC 61076-2-101	
<b>Ambient conditions</b>		
Ambient temperature		
Plug connector	-40 ... 90 °C (-40 ... 194 °F)	
Cable, fixed	-25 ... 70 °C (-13 ... 158 °F)	
Cable, flexing	-5 ... 70 °C (23 ... 158 °F)	
Pollution degree	3	
<b>Mechanical specifications</b>		
Plug connector		
Tightening torque	0.6 Nm	
Loosening protection	available	
Tool installation	straight knurling	
Mating cycles	min. 100	
Degree of protection	IP67 / IP68 / IP69	
Cable		
according to IEC/EN 60228 (DIN VDE 0295) class 5		
Sheath diameter	4.8 mm	
Bending radius	> 10 x cable diameter, moving	
Sheath stripping force	max. 80 N / 300 mm	
Sheath color	grey (similar to RAL 7001)	
Number of cores	3	
Core cross-section	0.34 mm <sup>2</sup>	
Cores color	Core 1: brown Core 3: blue Core 4: black	
Core construction	19 x 0.15 mm Ø	
Length	L	5 m
Cable code	Li Y YM 3 x 0,34	
<b>Material</b>		
Plug connector		
Screw connection	Zinc diecast, nickel-plated	
Body	TPU, transparent/black	
Contact surface	Au	
Flammability	V-2	
Cable		
Sheathing	PVC	
Core insulation	PVC	
Flammability	flame-resistant	

## Connection



Release date: 2021-04-05 Date of issue: 2021-04-05 Filename: 118365\_eng.pdf

**Accessories**

	<b>MH V1-SCREWDRIVER</b>	torque screwdriver (0.6 Nm)
	<b>MH V1-BIT M12</b>	plug-in cap M12
	<b>V1/V3-LABELHOLDER</b>	Label holder
	<b>V1/V3-LABEL</b>	Label plate
	<b>MH V1-Holder</b>	Modular universal holder for M12 connectors
	<b>V1-CLIP</b>	Unlocking protector for M12 connector
	<b>V1-MARKING-RING-COLOR</b>	Marking rings for M12 connectors, various colors

Release date: 2021-04-05 Date of issue: 2021-04-05 Filename: 118365\_eng.pdf

Refer to "General Notes Relating to Pepperl+Fuchs Product Information".

Pepperl+Fuchs Group  
www.pepperl-fuchs.com

USA: +1 330 486 0001  
fa-info@us.pepperl-fuchs.com

Germany: +49 621 776 1111  
fa-info@de.pepperl-fuchs.com

Singapore: +65 6779 9091  
fa-info@sg.pepperl-fuchs.com