



Connection cable

V1-W-E8W-BK4M-PUR-A-V1-G

- Improved resistance to weld spatter
- Suitable for drag chains and abrasion resistant
- Suitable for robotic applications / torsion resistant
- Built-in LED, as operating and function indicator
- Degree of protection IP67 / IP68 / IP69
- Free from substances that impair paint wetting
- Resistant to microbes and hydrolysis
- cURus approval
- Halogen-free
- Knurled nut suitable for tool assembly
- Immunity to vibration, with mechanical latching

Cordset M12 socket angled A-coded LED 4-pin to M12 plug straight A-coded 4-pin, PUR cable weld spatter resistant black, UL approved, drag chain suitable, torsion resistant



Dimensions

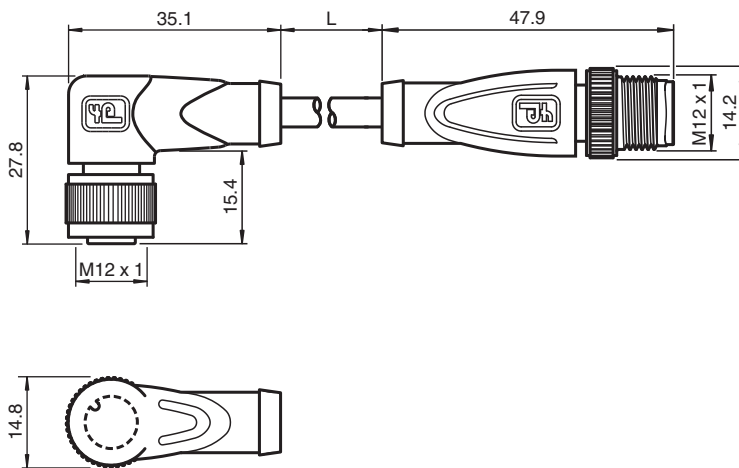

Technical Data

General specifications

Connector 1	
Connection	socket
Construction type	M12
Style	angled
Locking	screw connection
Number of pins	4
Coding	A-coded
Connector 2	
Connection	plug
Construction type	M12
Style	straight
Locking	screw connection
Number of pins	4
Coding	A-coded

Release date: 2020-12-03 Date of issue: 2020-12-03 Filename: 240784-0017_eng.pdf

Refer to "General Notes Relating to Pepperl+Fuchs Product Information".

Pepperl+Fuchs Group
www.pepperl-fuchs.com

USA: +1 330 486 0001
fa-info@us.pepperl-fuchs.com

Germany: +49 621 776 1111
fa-info@de.pepperl-fuchs.com

Singapore: +65 6779 9091
fa-info@sg.pepperl-fuchs.com

PEPPERL+FUCHS

Technical Data

UL File Number	E231213	
Indicators/operating means		
LED green	Operating display	
LED yellow	Functional display pin 4	
LED white	Functional display pin 2	
Electrical specifications		
Operating voltage	U _B	max. 24 V DC -20 % / +25 %
Operating current	I _B	max. 4 A
Conformity		
Degree of protection	EN 60529	
Plug connection	connector M12 x 1 : IEC 61076-2-101	
Flammability	UL 1581; DIN EN 60332-2-2	
Halogen-free	DIN VDE 0472-815 IEC 60754-1	
Microbial resistance	DIN EN 50525-2-21 / DIN VDE 0282-10	
Hydrolysis resistance	DIN EN 50525-2-21	
Approvals and certificates		
UL approval	AWM STYLE 20549 AWM I/II A/B 80°C 300V FT2 (cable)	
Ambient conditions		
Ambient temperature		
Plug connector	-40 ... 90 °C (-40 ... 194 °F)	
Cable, fixed	-40 ... 80 °C (-40 ... 176 °F)	
Cable, flexing	-25 ... 80 °C (-13 ... 176 °F)	
Pollution degree	3	
Mechanical specifications		
Plug connector		
Tightening torque	0.6 Nm	
Loosening protection	available	
Tool installation	straight knurling	
Mating cycles	min. 100	
Degree of protection	IP67 / IP68 / IP69	
Cable		
according to IEC/EN 60228 (DIN VDE 0295) class 6		
Sheath diameter	4.3 mm	
Bending radius	> 10 x cable diameter, moving > 5 x cable diameter, fixed	
Sheath stripping force	max. 80 N / 300 mm	
Sheath color	black (similar to RAL 9005)	
Number of cores	4	
Core cross-section	0.34 mm ²	
Cores color	Core 1: brown Core 2: white Core 3: blue Core 4: black	
Core construction	42 x 0.1 mm Ø	
Length	L	4 m
Cable code	Li F 9Y 11Y 4 x 0,34	
Drag chain suitability		
Drag chain cycles	min. 5000000	
Motion velocity	max. 3.3 m/s	
Traverse distance	max. 5 m	
Acceleration	max. 5 m/s ²	
Torsion cycles	min. 1000000	
Torsional stress	± 180 °/m	
Material		
LABS free	yes	

Release date: 2020-12-03 Date of issue: 2020-12-03 Filename: 240784-0017_eng.pdf

Refer to "General Notes Relating to Pepperl+Fuchs Product Information".

Pepperl+Fuchs Group
www.pepperl-fuchs.comUSA: +1 330 486 0001
fa-info@us.pepperl-fuchs.comGermany: +49 621 776 1111
fa-info@de.pepperl-fuchs.comSingapore: +65 6779 9091
fa-info@sg.pepperl-fuchs.com

PEPPERL+FUCHS

Technical Data

Halogen-free	yes
Plug connector	
Knurled screw connection	Zinc diecast, nickel-plated
Body	TPU, transparent/black
Contact surface	Au
Flammability	V-2
Cable	
Sheathing	PUR based on polyether
Core insulation	PP
Weld spatter resistance	yes
Chemical resistance	good
Oil resistance	yes
Cooling lubricant resistance	yes
Microbial resistance	yes
Hydrolysis resistance	yes
Flammability	FT2

Connection Assignment

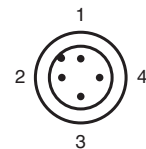
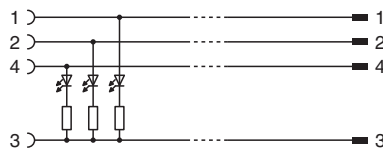
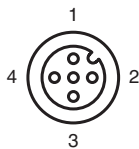

Release date: 2020-12-03 Date of issue: 2020-12-03 Filename: 240784-0017_eng.pdf