



Connection cable V1-G-YE1M-PVC-U-V1-W

- Degree of protection IP67 / IP68 / IP69
- cURus approval
- Knurled nut suitable for tool assembly
- Immunity to vibration, with mechanical latching

Cordset M12 socket straight to M12 plug angled A-coded, 4-pin, PVC cable yellow, UL approved



Dimensions

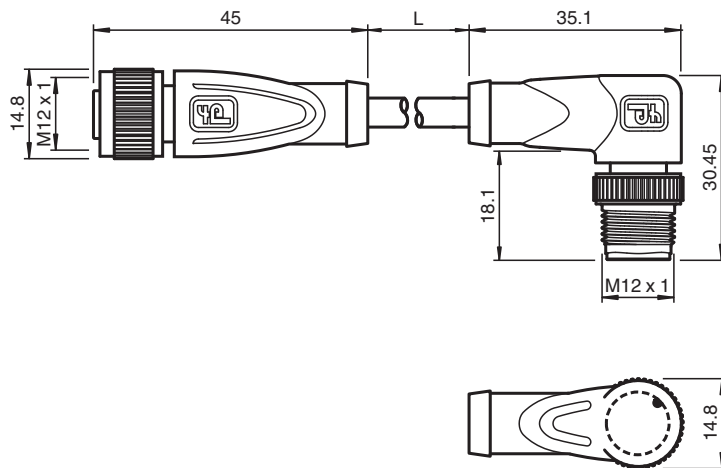

Technical Data

General specifications

Connector 1	
Connection	socket
Construction type	M12
Style	straight
Locking	screw connection
Number of pins	4
Coding	A-coded
Connector 2	
Connection	plug
Construction type	M12
Style	angled
Locking	screw connection
Number of pins	4
Coding	A-coded
UL File Number	E231213

Electrical specifications

Release date: 2021-04-18 Date of issue: 2021-04-18 Filename: 456589_eng.pdf

Refer to "General Notes Relating to Pepperl+Fuchs Product Information".

Pepperl+Fuchs Group
www.pepperl-fuchs.com

USA: +1 330 486 0001
fa-info@us.pepperl-fuchs.com

Germany: +49 621 776 1111
fa-info@de.pepperl-fuchs.com

Singapore: +65 6779 9091
fa-info@sg.pepperl-fuchs.com

PEPPERL+FUCHS





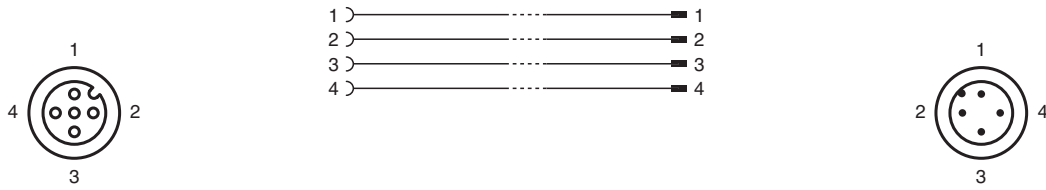

Technical Data

Operating voltage	U _B	max. 250 V AC/DC
Operating current	I _B	max. 4 A
Conformity		
Degree of protection		EN 60529
Plug connection		connector M12 x 1 : IEC 61076-2-101
Flammability		UL 1581 , IEC 60332-1-2
Approvals and certificates		
UL approval		AWM STYLE 2095 AWM I/II A/B 80°C 300V FT1 (cable)
Ambient conditions		
Ambient temperature		
Plug connector		-40 ... 90 °C (-40 ... 194 °F)
Cable, fixed		-25 ... 80 °C (-13 ... 176 °F)
Cable, flexing		-5 ... 80 °C (23 ... 176 °F)
Pollution degree		3
Mechanical specifications		
Plug connector		
Tightening torque		0.6 Nm
Loosening protection		available
Tool installation		straight knurling
Mating cycles		min. 100
Degree of protection		IP67 / IP68 / IP69
Cable		according to IEC/EN 60228 (DIN VDE 0295) class 5
Sheath diameter		4.3 mm
Bending radius		> 15 x cable diameter, moving > 5 x cable diameter, fixed
Sheath stripping force		max. 50 N / 300 mm
Sheath color		yellow (similar to RAL 1021)
Number of cores		4
Core cross-section		0.34 mm ²
Cores color		Core 1: brown Core 2: white Core 3: blue Core 4: black
Core construction		19 x 0.15 mm Ø
Length	L	1 m
Cable code		Li YY 4 x 0,34
Material		
Plug connector		
Screw connection		Zinc diecast, nickel-plated
Body		TPU, black
Contact surface		Au
Flammability		V-2
Cable		
Sheathing		PVC
Core insulation		PVC
Flammability		FT1

Connection Assignment



Accessories

	MH V1-SCREWDRIVER	torque screwdriver (0.6 Nm)
	MH V1-BIT M12	plug-in cap M12
	V1/V3-LABELHOLDER	Label holder
	V1/V3-LABEL	Label plate
	MH V1-Holder	Modular universal holder for M12 connectors
	V1-CLIP	Unlocking protector for M12 connector
	V1-MARKING-RING-COLOR	Marking rings for M12 connectors, various colors

Release date: 2021-04-18 Date of issue: 2021-04-18 Filename: 456589_eng.pdf