



Female connector V23-W-5M-PUR

- Sturdy design
- Plastic-coated
- Oil resistant

Female cordset, M23, 12-pin, PUR cable



Dimensions

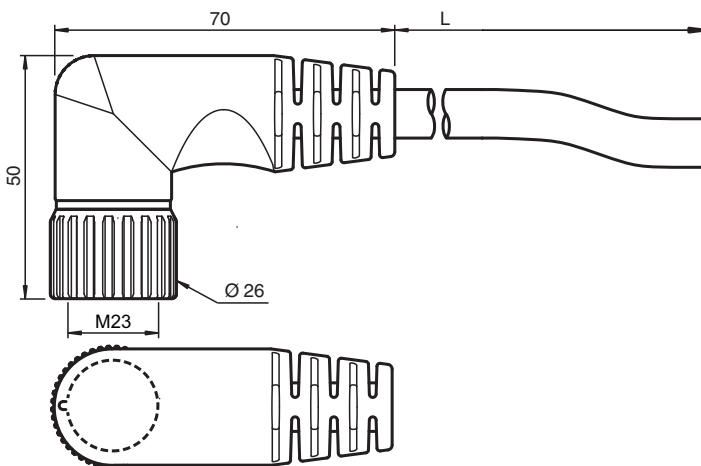

Technical Data

General specifications

Connector 1	
Connection	socket
Construction type	M23
Style	right angle
Locking	screw connection
Number of pins	12
Coding	A-coded
Connector 2	
Connection	cable end

Electrical specifications

Operating voltage	U_B	max. 48 V AC / 60 V DC
Operating current	I_B	8 A

Ambient conditions

Ambient temperature	
Plug connector	-40 ... 125 °C (-40 ... 257 °F)
Cable, fixed	-40 ... 90 °C (-40 ... 194 °F)

Release date: 2020-10-07 Date of issue: 2020-10-07 Filename: 183271_eng.pdf

Refer to "General Notes Relating to Pepperl+Fuchs Product Information".

Technical Data

Cable, flexing	-5 ... 80 °C (23 ... 176 °F)	
Pollution degree	2	
Mechanical specifications		
Plug connector		
Mating cycles	50	
Degree of protection	IP68	
Cable		
Sheath diameter	Ø 8.5 mm	
Bending radius	> 10 x cable diameter, moving	
Sheath color	black	
Cores	8 x 0.34 mm ² and 3 x 0.75 mm ²	
Core construction	19 x 0.15 mm and 42 x 0.15 mm	
Length	L	5 m
Material		
Plug connector		
Body	PUR	
Seal	FPM	
Contact surface	Au	
Cable		
Sheathing	PUR	
Core insulation	PVC	

Connection

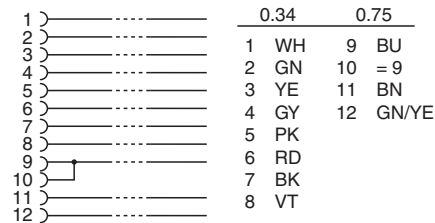
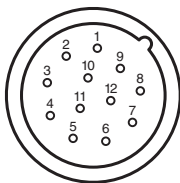

Release date: 2020-10-07 Date of issue: 2020-10-07 Filename: 183271_eng.pdf

Refer to "General Notes Relating to Pepperl+Fuchs Product Information".

Pepperl+Fuchs Group
www.pepperl-fuchs.com

USA: +1 330 486 0001
fa-info@us.pepperl-fuchs.com

Germany: +49 621 776 1111
fa-info@de.pepperl-fuchs.com

Singapore: +65 6779 9091
fa-info@sg.pepperl-fuchs.com