



## Connection cable

V15-W-E8-BK3M-PUR-A-V15-G

- Improved resistance to weld spatter
- Suitable for drag chains and abrasion resistant
- Suitable for robotic applications / torsion resistant
- Built-in LED, as operating and function indicator
- Degree of protection IP67 / IP68 / IP69
- Free from substances that impair paint wetting
- Resistant to microbes and hydrolysis
- cURus approval
- Halogen-free
- Knurled nut suitable for tool assembly
- Immunity to vibration, with mechanical latching

Cordset M12 socket angled A-coded LED 5-pin to M12 plug straight A-coded 5-pin, PUR cable weld spatter resistant black, UL approved, drag chain suitable, torsion resistant



### Dimensions

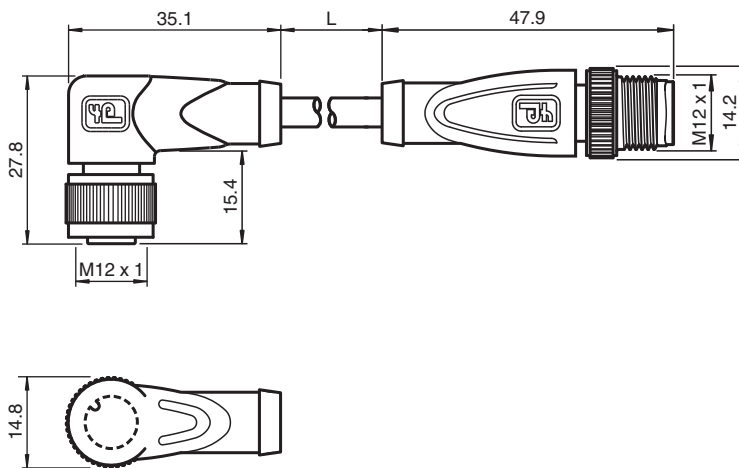

### Technical Data

#### General specifications

|                    |                  |
|--------------------|------------------|
| <b>Connector 1</b> |                  |
| Connection         | socket           |
| Construction type  | M12              |
| Style              | angled           |
| Locking            | screw connection |
| Number of pins     | 5                |
| Coding             | A-coded          |
| <b>Connector 2</b> |                  |
| Connection         | plug             |
| Construction type  | M12              |
| Style              | straight         |
| Locking            | screw connection |
| Number of pins     | 5                |
| Coding             | A-coded          |

Release date: 2020-12-09 Date of issue: 2020-12-09 Filename: 322566\_eng.pdf

Refer to "General Notes Relating to Pepperl+Fuchs Product Information".

Pepperl+Fuchs Group  
www.pepperl-fuchs.com

USA: +1 330 486 0001  
fa-info@us.pepperl-fuchs.com

Germany: +49 621 776 1111  
fa-info@de.pepperl-fuchs.com

Singapore: +65 6779 9091  
fa-info@sg.pepperl-fuchs.com

PEPPERL+FUCHS

## Technical Data

|  |   |                            |
|--|---|----------------------------|
| UL File Number                                   | E231213   |                            |
| <b>Indicators/operating means</b>                |   |                            |
| LED green  | Operating display   |                            |
| LED yellow                                       | Functional display pin 4  |                            |
| LED red  | Functional display pin 2  |                            |
| <b>Electrical specifications</b>                 |   |                            |
| Operating voltage                                | U <sub>B</sub>  | max. 24 V DC -20 % / +25 % |
| Operating current                                | I <sub>B</sub>  | max. 4 A                   |
| <b>Conformity</b>                                |   |                            |
| Degree of protection                             | EN 60529  |                            |
| Plug connection                                  | connector M12 x 1 : IEC 61076-2-101   |                            |
| Flammability                                     | UL 1581; DIN EN 60332-2-2   |                            |
| Halogen-free                                     | DIN VDE 0472-815<br>IEC 60754-1   |                            |
| Microbial resistance                             | DIN EN 50525-2-21 / DIN VDE 0282-10   |                            |
| Hydrolysis resistance                            | DIN EN 50525-2-21   |                            |
| <b>Approvals and certificates</b>                |   |                            |
| UL approval                                      | AWM STYLE 20549 AWM I/II A/B 80°C 300V FT2 (cable)                              |                            |
| <b>Ambient conditions</b>                        |   |                            |
| Ambient temperature                              |   |                            |
| Plug connector                                   | -40 ... 90 °C (-40 ... 194 °F)  |                            |
| Cable, fixed                                     | -40 ... 80 °C (-40 ... 176 °F)  |                            |
| Cable, flexing                                   | -25 ... 80 °C (-13 ... 176 °F)  |                            |
| Pollution degree                                 | 3   |                            |
| <b>Mechanical specifications</b>                 |   |                            |
| Plug connector                                   |   |                            |
| Tightening torque                                | 0.6 Nm  |                            |
| Loosening protection                             | available   |                            |
| Tool installation                                | straight knurling   |                            |
| Mating cycles                                    | min. 100  |                            |
| Degree of protection                             | IP67 / IP68 / IP69  |                            |
| Cable  |   |                            |
| according to IEC/EN 60228 (DIN VDE 0295) class 6 |   |                            |
| Sheath diameter                                  | 4.7 mm  |                            |
| Bending radius                                   | > 10 x cable diameter, moving<br>> 5 x cable diameter, fixed                    |                            |
| Sheath stripping force                           | max. 80 N / 300 mm  |                            |
| Sheath color                                     | black (similar to RAL 9005)   |                            |
| Number of cores                                  | 5   |                            |
| Core cross-section                               | 0.34 mm <sup>2</sup>  |                            |
| Cores color                                      | Core 1: brown<br>Core 2: white<br>Core 3: blue<br>Core 4: black<br>Core 5: grey |                            |
| Core construction                                | 42 x 0.1 mm Ø   |                            |
| Length   | L   | 3 m                        |
| Cable code                                       | Li F 9Y 11Y 5 x 0,34  |                            |
| Drag chain suitability                           |   |                            |
| Drag chain cycles                                | min. 5000000  |                            |
| Motion velocity                                  | max. 3.3 m/s  |                            |
| Traverse distance                                | max. 5 m  |                            |
| Acceleration                                     | max. 5 m/s <sup>2</sup>   |                            |
| Torsion cycles                                   | min. 1000000  |                            |
| Torsional stress                                 | ± 180 °/m   |                            |
| <b>Material</b>                                  |   |                            |

Release date: 2020-12-09 Date of issue: 2020-12-09 Filename: 322566\_eng.pdf

Refer to "General Notes Relating to Pepperl+Fuchs Product Information".

Pepperl+Fuchs Group  
www.pepperl-fuchs.comUSA: +1 330 486 0001  
fa-info@us.pepperl-fuchs.comGermany: +49 621 776 1111  
fa-info@de.pepperl-fuchs.comSingapore: +65 6779 9091  
fa-info@sg.pepperl-fuchs.com

**PEPPERL+FUCHS**

### Technical Data

|                              |                             |
|------------------------------|-----------------------------|
| LABS free                    | yes                         |
| Halogen-free                 | yes                         |
| Plug connector               |                             |
| Knurled screw connection     | Zinc diecast, nickel-plated |
| Body                         | TPU, transparent/black      |
| Contact surface              | Au                          |
| Flammability                 | V-2                         |
| Cable                        |                             |
| Sheathing                    | PUR based on polyether      |
| Core insulation              | PP                          |
| Weld spatter resistance      | yes                         |
| Chemical resistance          | good                        |
| Oil resistance               | yes                         |
| Cooling lubricant resistance | yes                         |
| Microbial resistance         | yes                         |
| Hydrolysis resistance        | yes                         |
| Flammability                 | FT2                         |

### Connection Assignment

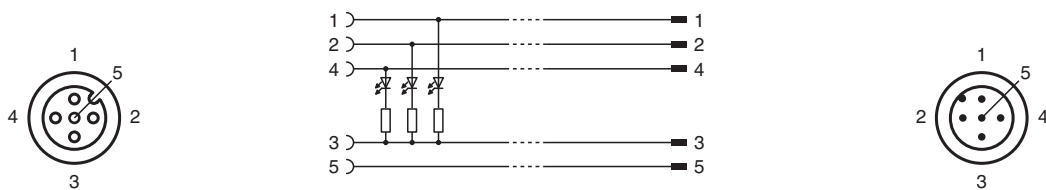

Release date: 2020-12-09 Date of issue: 2020-12-09 Filename: 322566\_eng.pdf