



Model Number

RL28-54-G-Z/47/112

Retroreflective sensor
with metal connector M12; 5-pin, 90°
convertible

Features

- Detects transparent objects, i.e., clear glass, PET and transparent films
- TEACH-IN switch for setting the contrast detection levels
- Automatic adjustment in case of soiling in contrast detection mode
- Ultra bright LEDs for power on, weak signal indication and switching state
- Flashing power on LED in case of short-circuit
- Not sensitive to ambient light, even with energy saving lamps
- Impulsed time element off-delay
- Waterproof, degree of protection IP67
- Protection class II

Dimensions

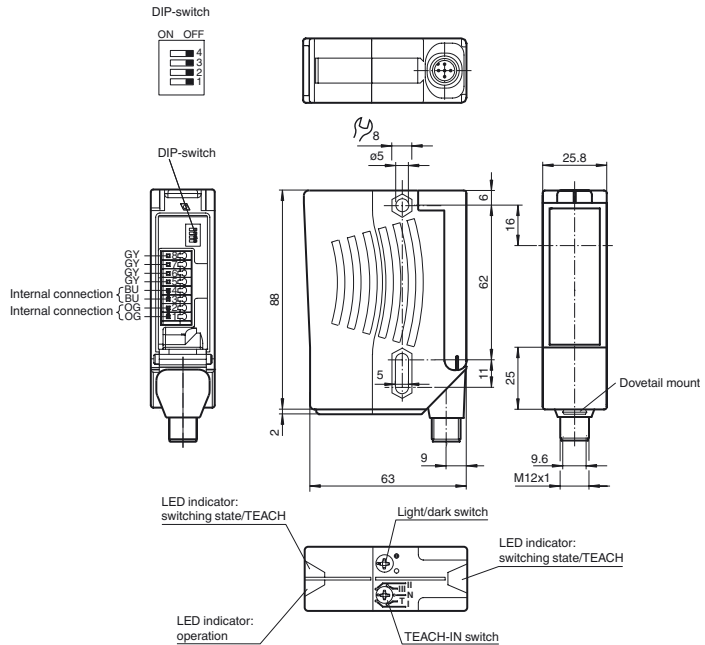

Electrical connection

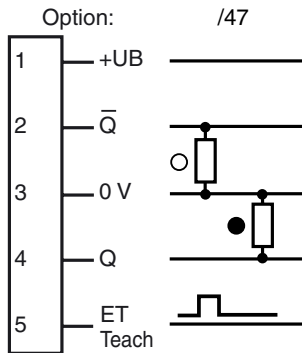

○ = Light on
● = Dark on

Pinout

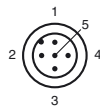

Wire colors in accordance with EN 60947-5-2

| | | |
|---|----|---------|
| 1 | BN | (brown) |
| 2 | WH | (white) |
| 3 | BU | (blue) |
| 4 | BK | (black) |
| 5 | GY | (gray) |

Release date: 2018-03-26 09:31 Date of issue: 2018-03-26 116659_eng.xml

Technical data**General specifications**

| | |
|----------------------------|--------------------------------------|
| Effective detection range | 0 ... 5.6 m |
| Reflector distance | 0 ... 5.6 m |
| Threshold detection range | 7 m |
| Reference target | H85-2 reflector |
| Light source | LED |
| Light type | modulated visible red light , 660 nm |
| Polarization filter | yes |
| Diameter of the light spot | approx. 90 mm at a distance of 5.6 m |
| Angle of divergence | Emitter: 1 ° Receiver: 1.2 ° |
| Ambient light limit | 50000 Lux |

Functional safety related parameters

| | |
|--------------------------------|--------|
| MTTF _d | 1020 a |
| Mission Time (T _M) | 20 a |
| Diagnostic Coverage (DC) | 0 % |

Indicators/operating means

| | |
|---------------------------|---|
| Operation indicator | LED green, flashes in case of short-circuit |
| Function indicator | 2 LEDs yellow for switching state, stability control, TEACH-IN and contrast detection mode |
| Control elements | rotary switch for light/dark, 5-step switch for contrast recognition adjustment |
| Contrast detection levels | 10 % - clean, water filled PET bottles 18 % - clear glass bottles 40 % - colored glass or opaque materials adjustable by Teach-In key or external wire |

Electrical specifications

| | | |
|------------------------|----------------|----------------|
| Operating voltage | U _B | 10 ... 30 V DC |
| Ripple | | 10 % |
| No-load supply current | I ₀ | ≤ 50 mA |

Input

| | |
|----------------|--------------------------|
| Function input | Ext. Teach-In input (ET) |
|----------------|--------------------------|

Output

| | | |
|---------------------|---|---------------------------------------|
| Switching type | light/dark on switchable | |
| Signal output | 2 PNP, complementary, short-circuit protected, reverse polarity protected , open collectors | |
| Switching voltage | max. 30 V DC | |
| Switching current | max. 200 mA | |
| Voltage drop | U _d | ≤ 2.5 V DC |
| Switching frequency | f | 1000 Hz |
| Response time | | 0.5 ms |
| Timer function | | Impulsed time element off-delay 20 ms |

Conformity

| | |
|------------------|--------------|
| Product standard | EN 60947-5-2 |
|------------------|--------------|

Ambient conditions

| | |
|---------------------|--------------------------------|
| Ambient temperature | -40 ... 60 °C (-40 ... 140 °F) |
| Storage temperature | -40 ... 75 °C (-40 ... 167 °F) |

Mechanical specifications

| | |
|----------------------|---|
| Housing width | 25.8 mm |
| Housing height | 88 mm |
| Housing depth | 65.5 mm |
| Degree of protection | IP67 |
| Connection | 5-pin, M12 x 1 connector, 90° rotatable |
| Material | |
| Housing | Plastic ABS |
| Optical face | Plastic pane |
| Connector | metal |
| Mass | 90 g |

Approvals and certificates

| | |
|--------------|--|
| UL approval | cULus |
| CCC approval | CCC approval / marking not required for products rated ≤36 V |

Accessories**OMH-05**

Mounting aid for round steel ø 12 mm or sheet 1.5 mm ... 3 mm

OMH-07

Mounting aid for round steel ø 12 mm or sheet 1.5 mm ... 3 mm

OMH-21

Mounting bracket

OMH-22

Mounting bracket

OMH-MLV11-K

dove tail mounting clamp

OMH-RLK29-HW

Mounting bracket for rear wall mounting

OMH-RL28-C

Weld slag cover model

Other suitable accessories can be found at www.pepperl-fuchs.com

Curves/Diagrams

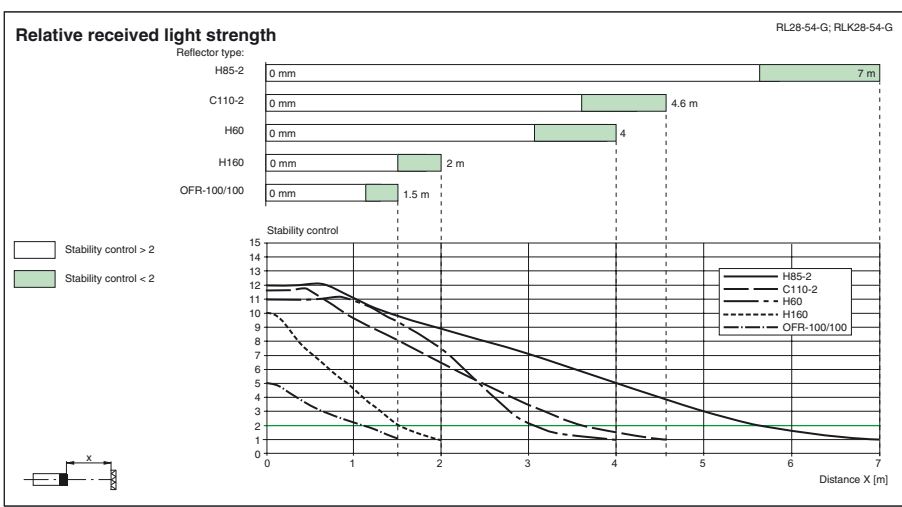
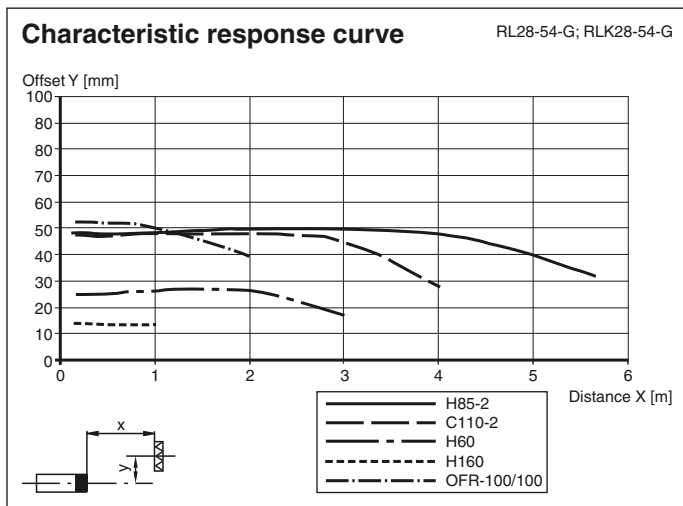

TEACH-IN

- Switch position "N" (standard operation):**
LEDs are lit when the light beam is unobstructed, they flash when the value falls short of the function reserve and they go out when the beam is interrupted.
- Switch position "T" (Teach-in mode):**
After 1 s, the LED flashes slowly (approx. 1.5 Hz). The sensor is now ready to be set for a specific contrast detection value either via the mechanical switch (pos. I, II or III) or an external signal.
- Switch positions "I", "II" and "III" (contrast detection mode)**
Contrast recognition values: I for 10 %, II for 18 %, III for 40 %
 - LED permanently lit: light path unobstructed
 - LED off: element to be sensed detected
 - LED flashes rapidly: detection failure, excessive soiling, function reserve too low.
- Ext. TEACH-IN input**
The desired contrast recognition capability can be adjusted by applying of a logic „high“ pulse with a certain pulse length when the switch is in position T.
 - I: 50 ms (30 ms ... 100 ms)
 - II: 150 ms (100 ms ... 200 ms)
 - III: > 200 ms
 It is possible to change the contrast detection level without re-teaching. For contrast detection mode (Teach-Mode) the stability reserve must be at least 2.5 (see curve „relative received light strength“).

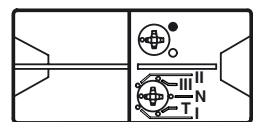

Timer functions

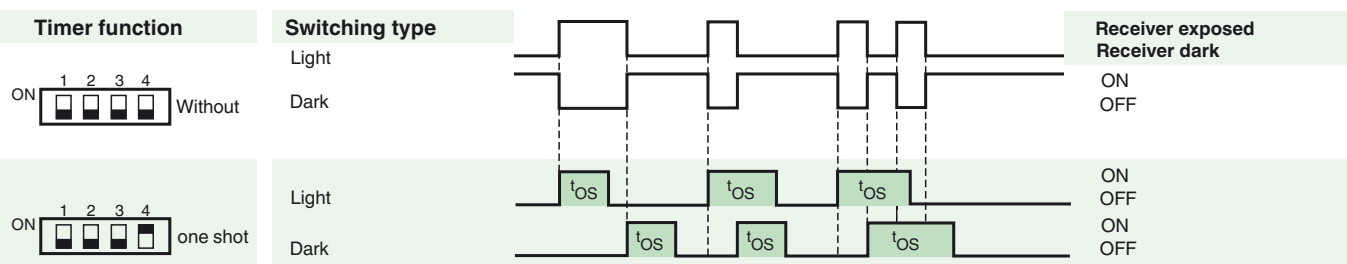

The Light-/Dark-Switch (Left, outer switch) is shown in the "Dark ON" position.

Release date: 2018-03-26 09:31 Date of issue: 2018-03-26 116659_eng.xml

| Type | Description | Notes |
|------|----------------|----------------------------|
| -Z | one shot timer | Fixed time interval 0.02 s |

Additional information

Mounting instructions:

The sensor is held in place by two pass-through drill holes for M5. The surface underneath must be flat to prevent the housing from moving when it is tightened into position. We recommend securing the nuts in place with spring screws to prevent the sensor from going out of adjustment.

Outdoor mounting:

The sensors must be protected from shock and splashed water. It may be necessary to provide a covering.

Adjustment:

Align the unit to the reflector in the "N" switch setting. The yellow LED must be lit constantly. Move the switch to the "T" setting and wait for about 1 sec. until the yellow LED starts flashing slowly.

Move the switch to the setting for the desired contrast detection level: "I" for 10%, "II" for 18%, "III" for 40%.

or

In switch setting "T", select the appropriate contrast detection level by applying a pulse through the control lead to connection pin 5 (see "TEACH-IN").

Contrast detection levels:

The output becomes inactive if dirt and dust make it impossible to readjust the setting. In this case the yellow LED will flash quickly.

If dirt and dust continue to accumulate, detection of slight contrasts can no longer be guaranteed.