



Model Number

ML9-54/59/103/123/134a/143

Retroreflective sensor
with 4-pin, M8 x 1 connector

Features

- Ultra bright LEDs for power on, weak signal indication and switching state
- Flashing power on LED in case of short-circuit
- TEACH-IN
- Not sensitive to ambient light, even with switched energy saving lamps
- Protected against mutual interference (no cross-talk)
- Protection class II

Dimensions

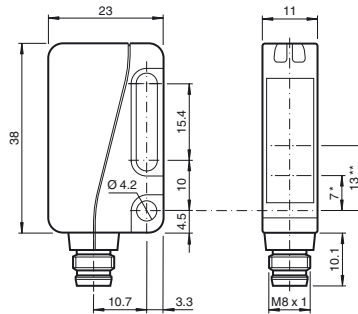

* optical axis transmitter
** optical axis receiver

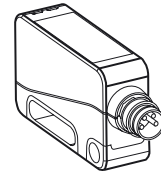
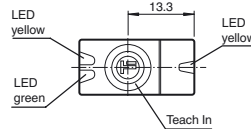

Electrical connection

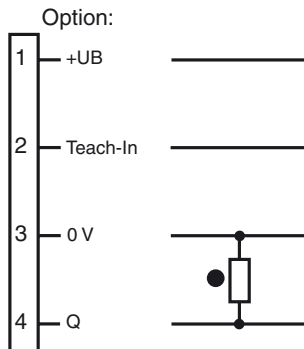

○ = Light on
● = Dark on

Pinout

Wire colors in accordance with EN 60947-5-2

1	BN	(brown)
2	WH	(white)
3	BU	(blue)
4	BK	(black)



Indicators/operating means

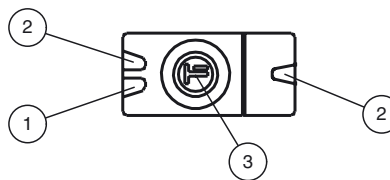

1	LED green
2	LED yellow
3	Teach-In

Release date: 2019-11-26 15:40 Date of issue: 2019-11-26 195289_eng.xml

Technical data**General specifications**

Effective detection range	0 ... 5 m
Threshold detection range	6 m
Reference target	H85-2 reflector
Light source	LED
Light type	modulated visible red light
Polarization filter	yes
Diameter of the light spot	approx. 110 mm at a distance of 3 m
Angle of divergence	approx. 2.1 °
Ambient light limit	30000 Lux

Functional safety related parameters

MTTF _d	1240 a
Mission Time (T _M)	20 a
Diagnostic Coverage (DC)	0 %

Indicators/operating means

Operation indicator	LED green, statically lit Power on , Undervoltage indicator: Green LED, pulsing (approx. 0.8 Hz) , short-circuit : LED green flashing (approx. 4 Hz)
Function indicator	LED yellow, lights up when light beam is free, flashes when falling short of the stability control
Control elements	Teach-In key

Electrical specifications

Operating voltage	U _B	10 ... 30 V DC , class 2
Ripple		max. 10 %
No-load supply current	I ₀	< 20 mA at 24 V

Input

Function input	Ext. Teach-In input (ET)
----------------	--------------------------

Output

Switching type	dark on	
Signal output	1 PNP output, short-circuit protected, reverse polarity protected, open collector	
Switching voltage	max. 30 V DC	
Switching current	max. 100 mA	
Voltage drop	U _d	≤ 2 V DC
Switching frequency	f	1000 Hz
Response time		0.5 ms

Conformity

Product standard	EN 60947-5-2
------------------	--------------

Ambient conditions

Ambient temperature	-25 ... 60 °C (-13 ... 140 °F)
Storage temperature	-40 ... 75 °C (-40 ... 167 °F)

Mechanical specifications

Housing width	23 mm
Housing height	38 mm
Housing depth	11 mm
Degree of protection	IP67
Connection	M8 x 1 connector, 4-pin
Material	
Housing	PC (glass-fiber-reinforced Makrolon)
Optical face	PMMA
Connector	plastic
Mass	approx. 15 g

Approvals and certificates

Protection class	II, rated voltage ≤ 50 V AC with pollution degree 1-2 according to IEC 60664-1
UL approval	cULus
CCC approval	CCC approval / marking not required for products rated ≤36 V

Accessories**OMH-ML9**

Mounting aid for ML9 series, Mounting bracket

OMH-ML9-01

Mounting aid for ML9 series, Threaded bolt M3

V31-GM-2M-PVC

Female cordset single-ended, M8, 4-pin, PVC cable

V31-WM-2M-PVC

Female cordset single-ended, M8, 4-pin, PVC cable

V31-GM-5M-PUR

Female cordset single-ended, M8, 4-pin, PUR cable

V31-WM-5M-PUR

Female cordset single-ended, M8, 4-pin, PUR cable

Other suitable accessories can be found at www.pepperl-fuchs.com

Curves/Diagrams

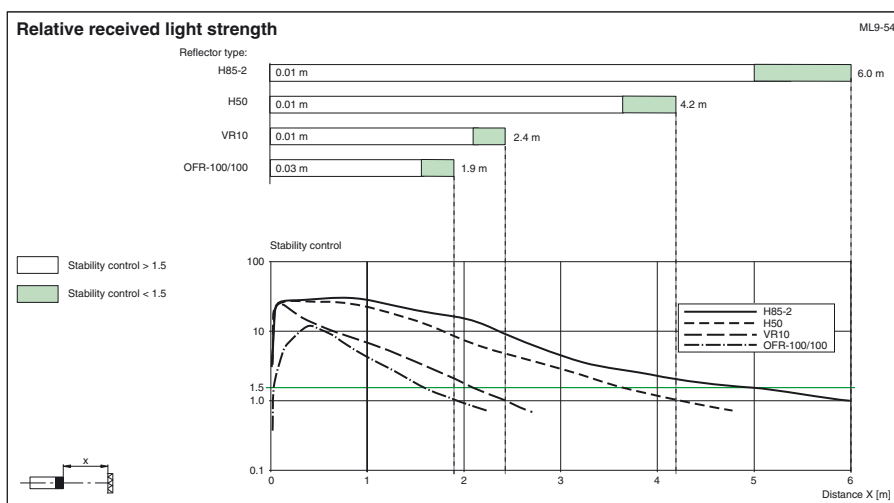
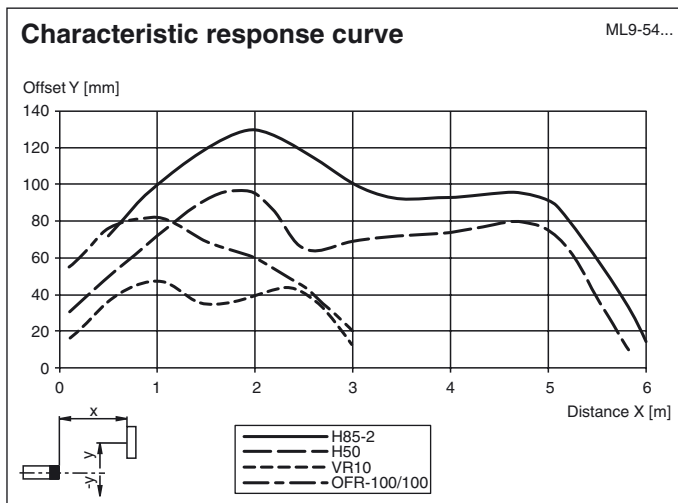

Setting Instructions

Setting Instructions for Devices with Teach-In

After the operating voltage is applied, the green LED lights up. The sensor is automatically in max. sensitivity status (state as supplied) or in the status of the most recent Teach-In setting.

Mount a suitable reflector opposite the photoelectric sensor.

Teach-In with the Teach key

- Align the sensor to a suitable reflector.
- Press the Teach key. The green LED indicator light goes off briefly to confirm this.
- Hold down the Teach key until the yellow and green indicator LEDs flash synchronously (about 2.5 Hz). Then release the Teach key
- During internal setup of the sensor, the green and yellow indicator LEDs flash alternately (about 2.5 Hz).
- Teach-In successful: The green and yellow indicator LEDs are lit. The device is ready for operation.
- Teach-In not successful: The green and yellow indicator LEDs flash quickly and alternately (about 8 Hz) for about 5 seconds. Then the sensor switches to the status with maximum sensitivity. After that, repeat the Teach-In procedure, starting with step 1.

Teach-In via external Teach-In input (ET)

Teach-In can also be initiated via the external Teach-In input (ET)

To do this, the ET must be open (or at 0 V) for at least 50 ms, after which +UB is applied for a duration of 50 to 80 ms.

Teach-In lasts for a maximum of 11 seconds (if not successful)

