



**Model Number**

**ML7-54-G-4541**

Retroreflective sensor  
Fixed cable 3m with M16 cable gland type Jacob and AMP-plug, 6-pin

**Features**

- Reliable sensor for standard applications
- Miniature design with versatile mounting options
- Detects transparent materials
- TEACH-IN switch for setting the contrast detection levels
- Automatic adjustment in case of soiling in contrast detection mode
- Certified by ECOLAB

**Product information**

Small, robust, effective, and reliable - these are the properties of the ML7 sensor series. Due to their small size, number of versions, and two different lens positions, they are particularly suited for installation in tight spaces. The robust design and high quality of Pepperl+Fuchs mean they can also be used under harsh environmental conditions. The efficient technology, switching frequencies up to 1000 Hz, high resistance to ambient light, and 4-in-1 output make the series suitable for non-contact object detection.

**Dimensions**

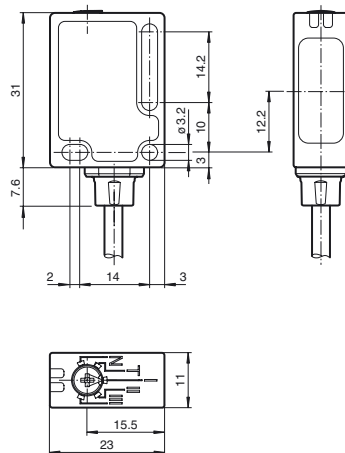

**Electrical connection**

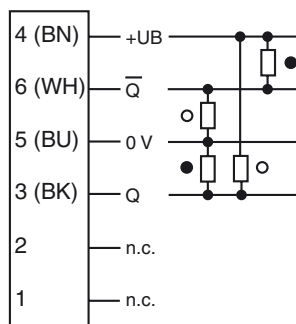

○ = Light on  
● = Dark on

**Pinout**

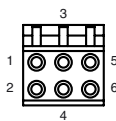

**Indicators/operating means**

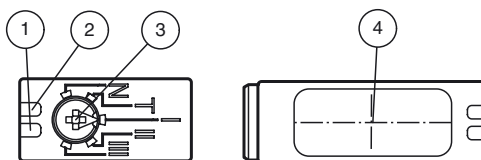

1	Operating display	green
2	Signal display	yellow
3	Teach-In	
4	Optical center	

Release date: 2020-01-15 09:10 Date of issue: 2020-01-15 218095\_eng.xml

Refer to "General Notes Relating to Pepperl+Fuchs Product Information".

**Technical data****General specifications**

Effective detection range	0 ... 3.5 m in TEACH mode 0 ... 5.7 m at switch position "N"
Reflector distance	0 ... 3.5 m in TEACH mode 0 ... 5.7 m at switch position "N"
Threshold detection range	7.6 m
Reference target	H85-2 reflector
Light source	LED
Light type	modulated visible red light , 660 nm
Polarization filter	yes
Angle deviation	max. $\pm 1^\circ$
Diameter of the light spot	approx. 40 mm at detection range 1 m
Angle of divergence	1.7 °
Ambient light limit	40000 Lux

**Indicators/operating means**

Operation indicator	LED green, statically lit Power on , Undervoltage indicator: Green LED, pulsing (approx. 0.8 Hz) , short-circuit : LED green flashing (approx. 4 Hz)
Function indicator	LED yellow: switching state ; Stability control ; Teach-In
Control elements	5-step switch for setting the contrast detection levels.
Contrast detection levels	10 % - clean, water filled PET bottles 18 % - clear glass bottles 40 % - colored glass or opaque materials adjustable due to Teach-In switch

**Electrical specifications**

Operating voltage	$U_B$	10 ... 30 V DC
Ripple		max. 10 %
No-load supply current	$I_0$	< 20 mA at 24 V DC

**Output**

Switching type	light on	
Signal output	2 push-pull (4 in 1) outputs, complementary, short-circuit proof, reverse polarity protected	
Switching voltage	max. 30 V DC	
Switching current	max. 100 mA	
Switching frequency	$f$	1 kHz
Response time		500 $\mu$ s

**Conformity**

Product standard	EN 60947-5-2
------------------	--------------

**Ambient conditions**

Ambient temperature	-20 ... 60 °C (-4 ... 140 °F)
Storage temperature	-40 ... 75 °C (-40 ... 167 °F)

**Mechanical specifications**

Housing width	11 mm
Housing height	31 mm
Housing depth	23 mm
Degree of protection	IP67 / IP69K
Connection	3 m fixed cable with cable gland type Jacob 50.616 PA/R (M16) and AMP connector type 926476-3 , 6-pin
Material	
Housing	PC (glass-fiber-reinforced Makrolon)
Optical face	PMMA
Mass	50 g

**Approvals and certificates**

Protection class	II, rated voltage $\leq 50$ V AC with pollution degree 1-2 according to IEC 60664-1 functional insulation acc. to DIN EN 50178
UL approval	cULus
CCC approval	CCC approval / marking not required for products rated $\leq 36$ V

**Accessories****Montagekit OMH-ML7-01**

Mounting set consisting of bracket OMH-ML-01 sheet OMH-ML7-03, and fastening material

**Montagekit OMH-ML7-02**

Mounting set consisting of bracket OMH-ML-02 sheet OMH-ML7-03, and fastening material

**OMH-ML7-01**

Mounting aid for ML7 and ML8 series, Mounting bracket

**OMH-ML7-02**

Mounting aid for ML7 and ML8 series, Mounting bracket

**OMH-ML7-03**

Mounting aid for ML7 and ML8 series, Fixing plate

Suitable reflectors and cable sockets can be found in the Internet

**Curves/Diagrams**

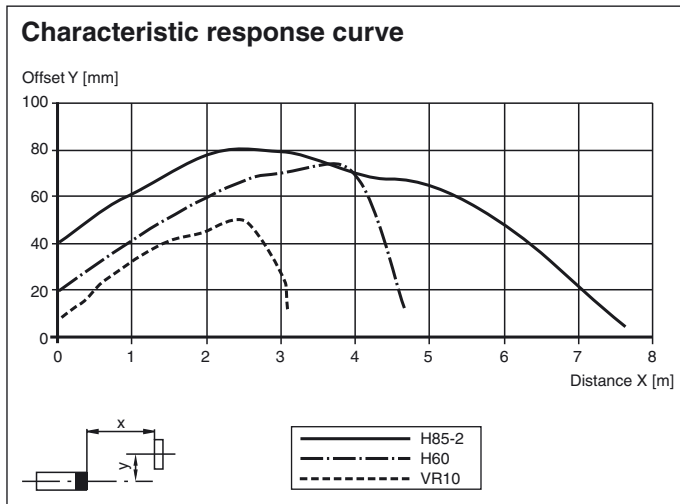

**Curves/Diagrams**

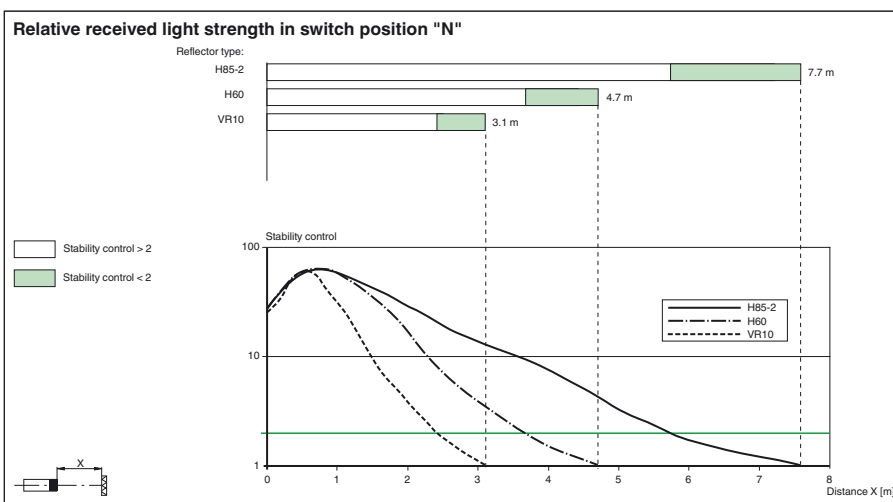
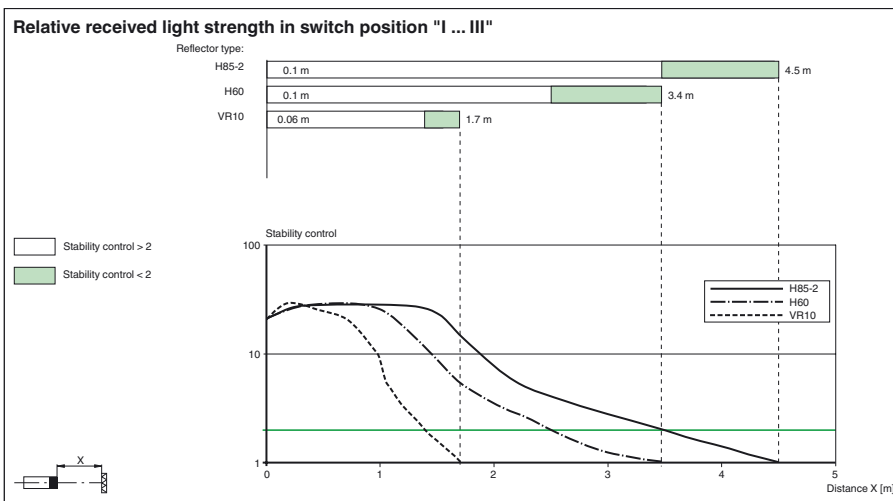

**Additional information**

**Adjustment instructions for Teach-In operation:**

Step	Switch position	LED green	LED yellow	Time/frequency	Explanations/comments
------	-----------------	-----------	------------	----------------	-----------------------

Release date: 2020-01-15 09:10 Date of issue: 2020-01-15 218095\_eng.xml

Refer to "General Notes Relating to Pepperl+Fuchs Product Information".

1	N	on	flashes	4/s	In switch position "N" directed towards reflector. Reflector detected <b>without function reserve</b> .
	N	on	on	-	In switch position "N" directed towards reflector. Reflector detected <b>with function reserve</b> (recommended).
2	T	off/on	on	200 ms	The selection of a new switch position is indicated by the green LED going out for a short time. This also applies to the selection of the other switch positions.
	T	flashes	flashes	2.5 s	<i>Slow</i> alternating flashing: Teach-In process has been performed <b>correctly</b> . Max. duration of the Teach-In process: 2 s
	T	flashes	flashes	8/s	<i>Quick</i> alternating flashing: Teach-In process has <b>not</b> been performed <b>correctly</b> . (e.g. receiver signal not sufficient, sensor not directed correctly towards reflector). Status is terminated by turning switch to position N.
3/1	I	on	on	-	Contrast detection 10 % is activated. (e.g. clean PET bottles filled with water)
3/2	II	on	on	-	Contrast detection 18 % is activated. (e.g. clear glass bottles)
3/3	III	on	on	-	Contrast detection 40 % is activated. (e.g. coloured glass or non-transparent materials)