

CS30-N30NO80P-A12

Mind O≠0, I≠I≠1, S≠5, B≠8.

Housing dimension	M30×1.5
Mounting	non-flush
Sensing distance S_n	30 mm
Operating voltage	10...30 V _{DC}
Reverse polarity protection	built-in
Current consumption	<9 mA
Current load capability	200 mA
Output function	normally open
Output polarity	NPN
Short circuit protection	built-in, self-resetting
Voltage drop	<2 V @ 200 mA
Switching frequency	100 Hz
Adjustment	multi-turn potentiometer
Operating temperature	-20...+70 °C · -3...+159 °F
Protection class	IP67
Sensing face material	PBT
Housing material	PBT
Switching indicator	built-in
Connection	male connector M12
Complies with	CE, RoHS



Capacitive Proximity Switch 3-Wire DC Sensing range: *Increased*

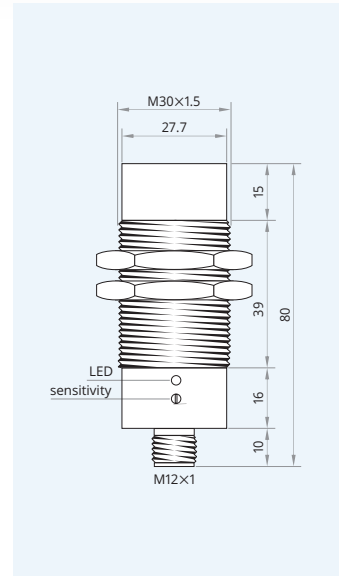

Warranty Our products are manufactured to stringent ISO 9001 European standards to ensure that our customers only receive the best quality.



Wiring diagram

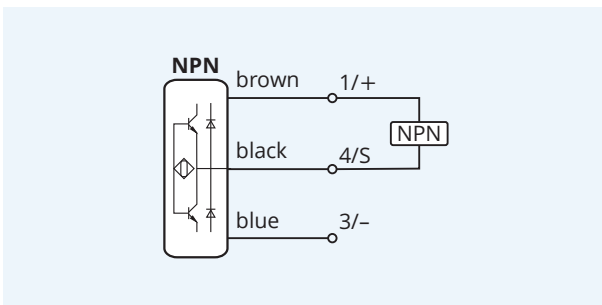

Pinout

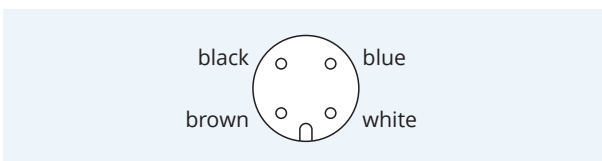

Caution! This device shall not be used if the safety of persons rely on its faultless function.

XECRO reserves the right to make minor changes without prior notification.