

Cable connector, NAMUR

V1-WV4A-N-30M-PUR

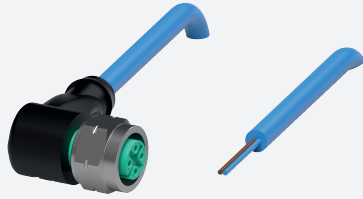

- Suitable for NAMUR technology
- Degree of protection IP68 / IP69
- Screw connection stainless steel
- Suitable for routing intrinsically safe circuits in accordance with DIN EN 60079-14:2014
- Specific design protects against loosening and inaccurate installation

Female cordset single-ended M12 angled stainless steel 1.4404, A-coded, 2-pin, PUR cable blue, NAMUR



Dimensions

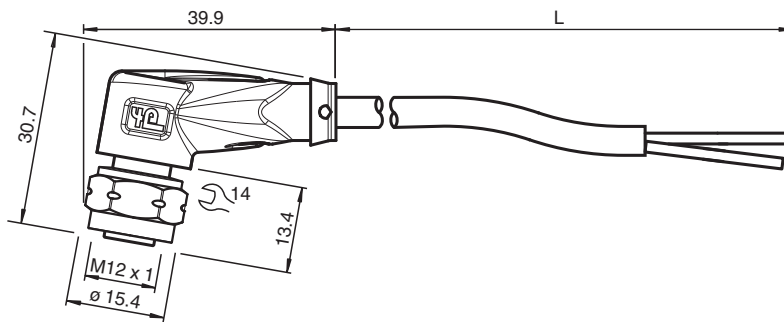

Technical Data

General specifications

| | |
|-------------------|------------------|
| Connector 1 | |
| Connection | socket |
| Construction type | M12 |
| Style | angled |
| Locking | screw connection |
| Number of pins | 2 |
| Coding | A-coded |
| Connector 2 | |
| Connection | cable end |

Electrical specifications

| | | |
|-----------------------------|-------|------------------------|
| Operating voltage | U_B | max. 250 V AC/DC |
| Operating current | I_B | 4 A |
| Resistance per unit length | R' | max. 0.057 Ω /m |
| Capacitance per unit length | C' | 102.4 nF/km |
| Inductance per unit length | L' | 0.49 mH/km |

Conformity

| | |
|----------------------|-------------------------------------|
| Degree of protection | EN 60529 |
| Plug connection | connector M12 x 1 : IEC 61076-2-101 |

Ambient conditions

| | |
|---------------------|--|
| Ambient temperature | |
|---------------------|--|

Release date: 2023-09-04 Date of issue: 2023-09-04 Filename: 70127859_eng.pdf

Refer to "General Notes Relating to Pepperl+Fuchs Product Information".

Pepperl+Fuchs Group
www.pepperl-fuchs.com

USA: +1 330 486 0001
fa-info@us.pepperl-fuchs.com

Germany: +49 621 776 1111
fa-info@de.pepperl-fuchs.com

Singapore: +65 6779 9091
fa-info@sg.pepperl-fuchs.com

PEPPERL+FUCHS



Technical Data

| | | |
|----------------------------------|---|---|
| Plug connector | | -40 ... 90 °C (-40 ... 194 °F) |
| Cable, fixed | | -40 ... 80 °C (-40 ... 176 °F) |
| Cable, flexing | | -20 ... 80 °C (-4 ... 176 °F) |
| Pollution degree | | 3 |
| Mechanical specifications | | |
| Plug connector | | |
| Tightening torque | | 0.6 Nm |
| Tool installation | | hexagon nut SW = 14 mm |
| Mating cycles | | min. 100 |
| Degree of protection | | IP68 / IP69 |
| Cable | | according to IEC/EN 60228 (DIN VDE 0295) class 6 |
| Sheath diameter | | 4.8 mm |
| Bending radius | | > 15 x cable diameter, moving > 10 x cable diameter, fixed |
| Sheath color | | blue (similar to RAL 5015) |
| Number of cores | | 2 |
| Core cross section | | 0.34 mm ² |
| Cores color | | Core 1: brown Core 2: blue |
| Core construction | | 42 x 0.1 mm Ø |
| Length | L | 30 m |
| Cable code | | Li FY 11Y 2 x 0.34 |
| Material | | |
| Plug connector | | |
| Screw connection | | Stainless steel 1.4404 / AISI 316L |
| Body | | TPU, black |
| Seal | | FKM |
| Contact surface | | gold plated (Au) |
| Flammability | | V-2 |
| Cable | | |
| Sheathing | | PUR based on polyether |
| Core insulation | | PVC |
| Flammability | | HB |

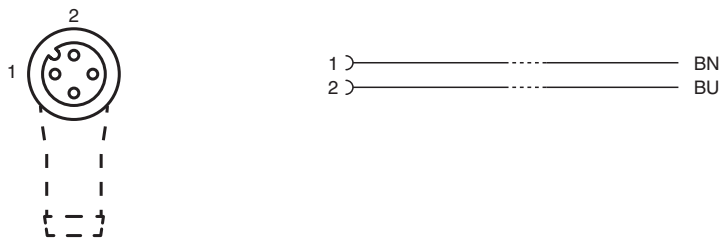
Connection







Accessories

| | | |
|---|----------------------------------|---|
|  | MH V1-SCREWDRIVER | Torque screwdriver (0.6 Nm) |
|  | MH V1-BIT M12-W14-HEX | Plug-in attachment for M12 with hex stainless steel knurled nut |
|  | V1/V3-LABELHOLDER | Label holder |

Refer to "General Notes Relating to Pepperl+Fuchs Product Information".

Accessories

| | | |
|---|------------------------------|--|
|  | V1/V3-LABEL | Label plate |
|  | MH V1-Holder | Modular universal holder for M12 connectors |
|  | V1-CLIP | Unlocking protector for M12 connector |
|  | V1-MARKING-RING-COLOR | Marking rings for M12 connectors, various colors |