

Photoelectric slot sensor GL3-T/153-Y70138368



- Miniature design
- Optimized for the detection of small parts
- High switching frequency

Miniature photoelectric slot sensor for the detection of small parts, T-shaped housing design, 3.15 mm slot width, infrared light, NPN outputs, fixed cable



Function

The GL2 & GL3 miniature slot sensor is the smallest slot sensor in its family optimized to the requirements in semiconductors industry for small part detection. A wide voltage range of 5 V DC ... 30 V DC and a extreme fast response time of 25 µs stands for the quality of this sensor. The GL2 & GL3 sensor can be directly connected to a comparator or Schmitt-trigger circuit. Due to a variety of different housings and an optimized housing concept offers the sensor a maximum of freedom in a crowded mounting environment.

Dimensions

1	collector
2	emitter
3	anode
4	cathode
5	collector

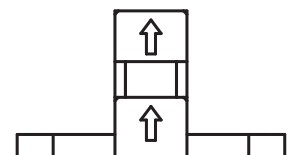
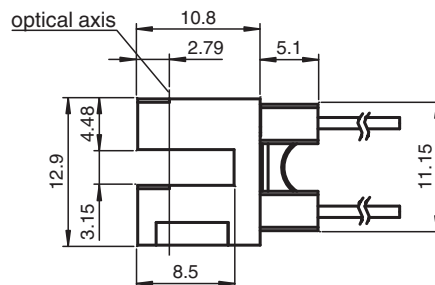
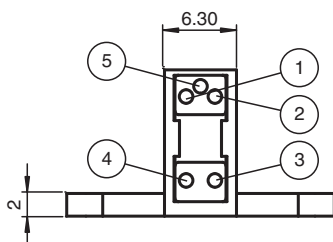
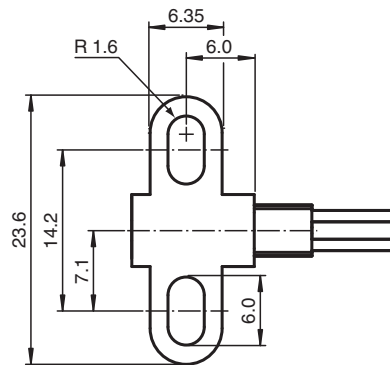

Release date: 2022-08-08 Date of issue: 2022-08-08 Filename: 70138368_eng.pdf

Refer to "General Notes Relating to Pepperl+Fuchs Product Information".

Pepperl+Fuchs Group
www.pepperl-fuchs.com

USA: +1 330 486 0001
fa-info@us.pepperl-fuchs.com

Germany: +49 621 776 1111
fa-info@de.pepperl-fuchs.com

Singapore: +65 6779 9091
fa-info@sg.pepperl-fuchs.com

pf PEPPERL+FUCHS

Technical Data

General specifications		
Light source		IRED , 940 nm
Light type		IRED
Slot width		3.15 mm
Slot depth		3.15 mm
Ambient light limit		1000 Lux
Electrical specifications		
Operating voltage	U_B	5 ... 30 V DC
Ripple		10 %
Emitter		
Light type		940 nm IR light
Forward voltage	V_F	< 1.6 V
Peak forward voltage	V_{FM}	30 V
Forward current	I_F	50 mA
Pulse current	I_{FM}	1 A
Reverse voltage	V_R	5 V
Reverse current	I_R	≤ 10 μA
Power dissipation		75 mW
Receiver		
Output type		NPN
C-E breakdown voltage	V_{CEO}	30 V
E-C breakdown voltage	V_{ECO}	5 V
Collector dark current	I_{CEO}	< 1 μA
Collector DC current	I_C	20 mA
Power dissipation	P_D	75 mW
Output		
Signal output		1 NPN , photo transistor
Switching voltage		max. 30 V DC
Switching current		20 mA
Response time		25 μs
Approvals and certificates		
EAC conformity		TR CU 020/2011
CCC approval		CCC approval / marking not required for products rated ≤36 V
Ambient conditions		
Ambient temperature		-20 ... 85 °C (-4 ... 185 °F)
Storage temperature		-40 ... 85 °C (-40 ... 185 °F)
Mechanical specifications		
Core cross section		4 x 0.08 mm ²
Housing width		23.6 mm
Housing height		12.9 mm
Housing depth		15.9 mm
Degree of protection		IP30
Connection		610 mm, PVC cable , Individual colored wires
Material		
Housing		PC
Mass		7 g

Release date: 2022-08-08 Date of issue: 2022-08-08 Filename: 70138368_eng.pdf

Refer to "General Notes Relating to Pepperl+Fuchs Product Information".

Pepperl+Fuchs Group
www.pepperl-fuchs.comUSA: +1 330 486 0001
fa-info@us.pepperl-fuchs.comGermany: +49 621 776 1111
fa-info@de.pepperl-fuchs.comSingapore: +65 6779 9091
fa-info@sg.pepperl-fuchs.com
 PEPPERL+FUCHS

Connection Assignment

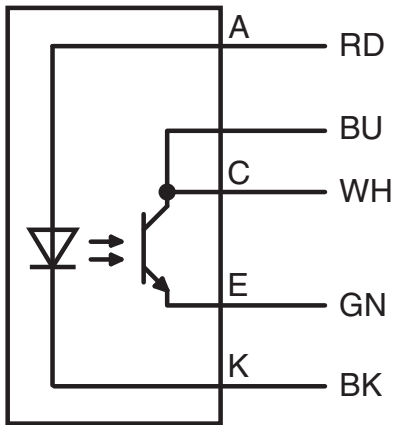

Characteristic Curve

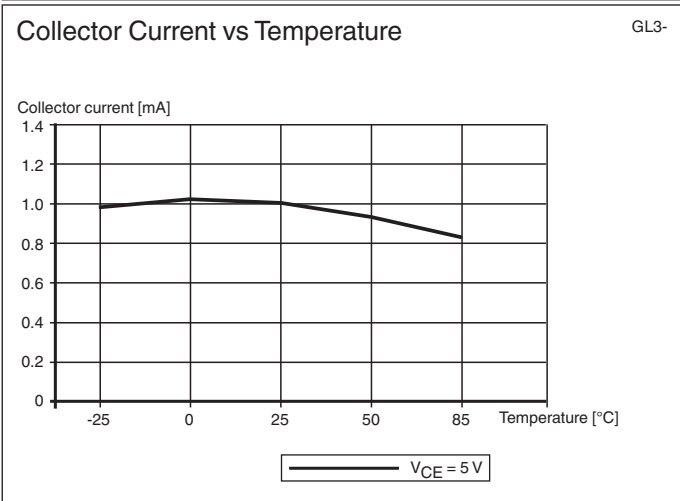
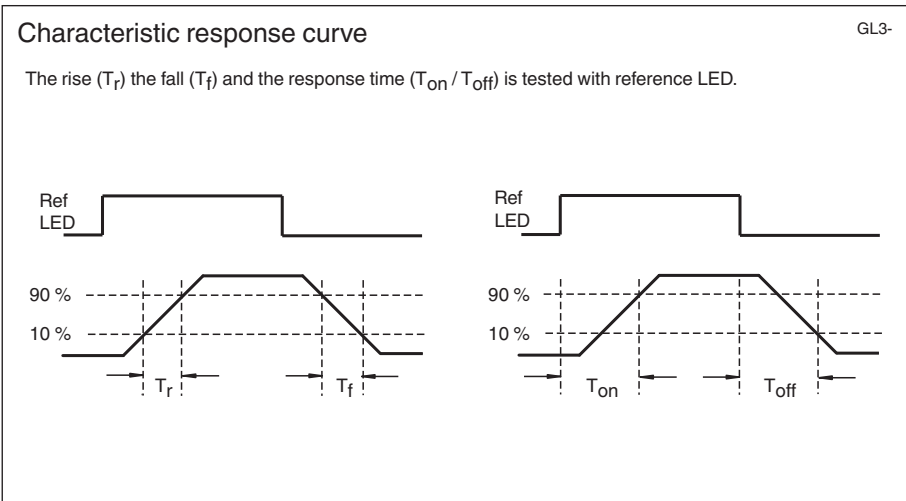

Release date: 2022-08-08 Date of issue: 2022-08-08 Filename: 70138368_eng.pdf

Characteristic Curve

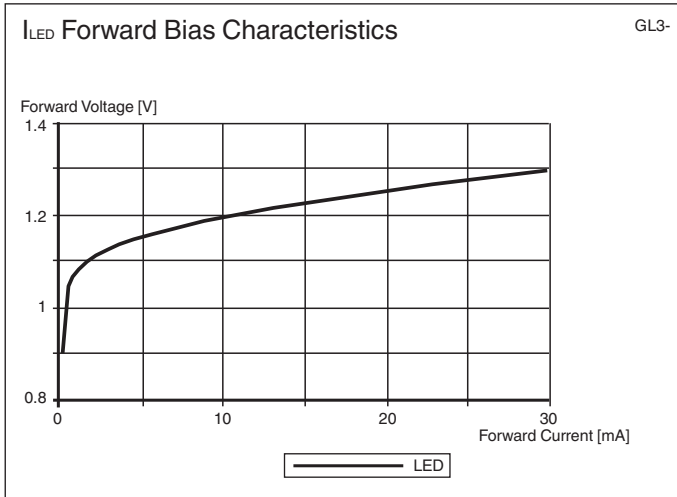
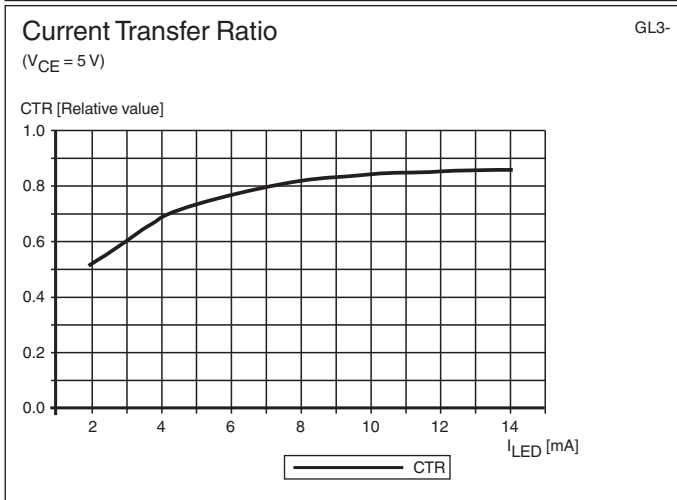
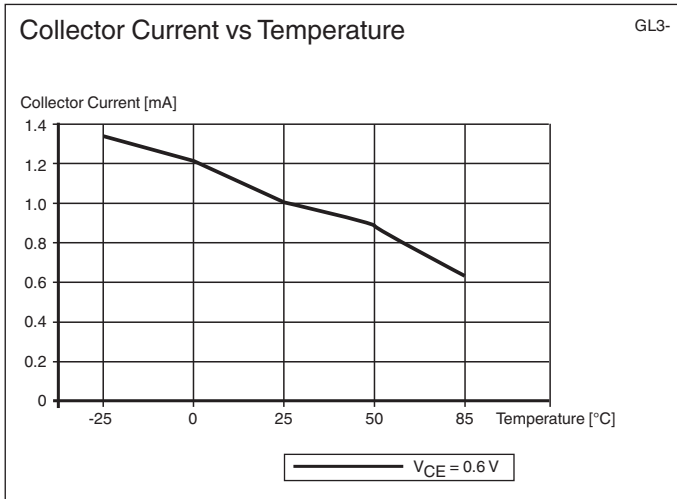

Release date: 2022-08-08 Date of issue: 2022-08-08 Filename: 70138368_eng.pdf

Characteristic Curve

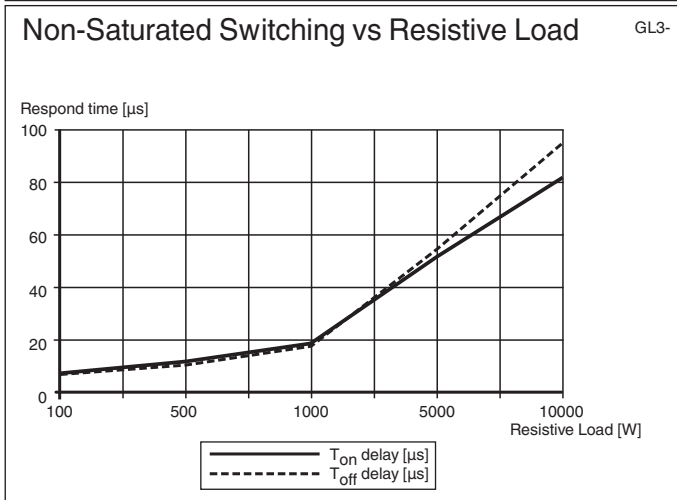
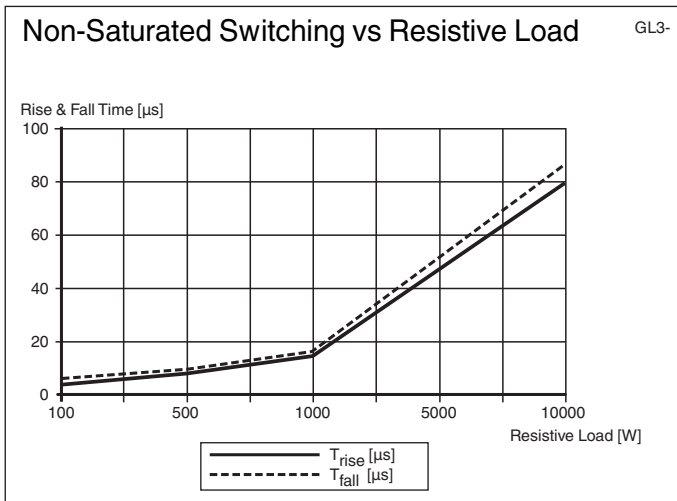

Release date: 2022-08-08 Date of issue: 2022-08-08 Filename: 70138368_eng.pdf

Refer to "General Notes Relating to Pepperl+Fuchs Product Information".

Connection example

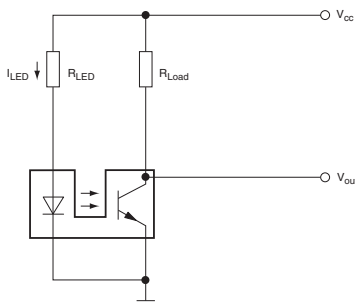

3 simple steps:

- Choose power supply
- Choose LED current (set resistor R_{LED})
- Choose load current (set resistor R_{LOAD})

Possible connections

<p>Circuit with voltage comparator</p>	<p>Circuit with additional transistor</p>
<p>Circuit with Op Amp</p>	<p>Circuit with PNP transistor output</p>

Release date: 2022-08-08 Date of issue: 2022-08-08 Filename: 70138368_eng.pdf