

AS-Interface I/O module

VBA-4E4A-G20-ZEJ/M48L-P12



- Inputs for 3-wire sensors
- A/B node with extended addressing possibility for up to 62 nodes
- Connection of motors and sensors via M8 connectors
- Power supply of outputs from auxiliary voltage AUX
- Supply for inputs from AS-Interface
- Cable piercing method with gold plated contact pins
- Outputs for 48 V DC roller motors

G20 motor control module for Interroll EC5000 48V AI



Function

The AS-Interface connecting module is a field module with two sensor inputs and two electronic outputs for controlling DC roller motors of the type Interroll EC5000 48V AI.

The compact housing can be installed directly into support profiles or cable ducts. It is connected to the AS-Interface network and the auxiliary energy using insulation piercing technology via the AS-Interface flat cable. The swiveling flat cable guide is locked without the use of tools. The sensor inputs and motor outputs are connected using cable outputs with M8 round plug connectors. The inputs are supplied via the AS-Interface. The motors are supplied via the external auxiliary voltage U_{AUX} .

The current switching state of the sensor inputs, the presence of supply voltage at the motors, the operating state of the motors (stationary/in operation), the direction of rotation, and the setting of the fault signal via a motor is displayed via LEDs.

Using AS-Interface data bits, the motors can be switched on or off individually, the direction of rotation can be changed, and the speed of the motor can be controlled. The voltage for the speed signal and a separate direction of rotation for motor 2 can be controlled via AS-Interface parameters.

To control the acceleration and to stop the motors, a start/stop ramp can be set for the speed signal. The time period of the ramp can be selected from eight preset values and can be configured. Once selected, the ramp is stored in non-volatile memory and automatically activated after each switch-on. The ramp is not effective if the direction of rotation signal is switched when the motor is running. In this case, the direction of rotation is reversed immediately.

Note:

The communication monitor of the module deactivates the outputs if the AS-Interface does not communicate with the module for more than 40 ms. Inputs IN1 and IN2 suppress pulses that are shorter than 2 ms. An overload of the input supply, an overload of the speed signal, or a lack of external auxiliary voltage is reported to the AS-Interface gateway via the "Peripheral error" function. The communication via AS-Interface remains unaffected.

Dimensions

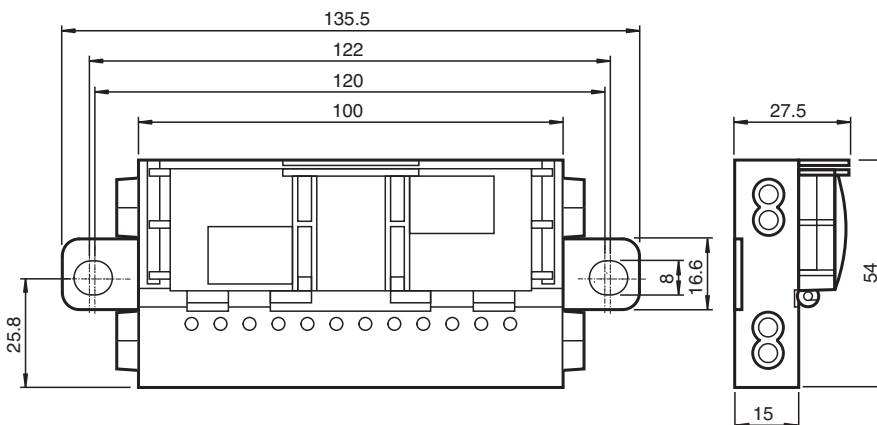

Technical Data

General specifications

Node type	A/B node
-----------	----------

Release date: 2023-09-26 Date of issue: 2023-09-26 Filename: 70145537_eng.pdf

Refer to "General Notes Relating to Pepperl+Fuchs Product Information".

Pepperl+Fuchs Group
www.pepperl-fuchs.com

USA: +1 330 486 0001
fa-info@us.pepperl-fuchs.com

Germany: +49 621 776 1111
fa-info@de.pepperl-fuchs.com

Singapore: +65 6779 9091
fa-info@sg.pepperl-fuchs.com



Technical Data

AS-Interface specification		V3.0
Required gateway specification		≥ V3.0
Profile		S-7.A.7
IO code		7
ID code		A
ID1 code		7
ID2 code		7
MTBF		98 a
Compatible roller motors		Interroll EC5000 48V AI (20W/35W/50W)
Indicators/operating means		
LED FAULT		error display; LED red red: communication error or address is 0 red flashing: overload of sensor supply or speed signal overload or external auxiliary voltage U_{AUX} missing
LED ERR		Motor fault: 2 LED yellow
LED PWR		AS-Interface voltage; green LED green: voltage OK green flashing: address 0 or sensor supply overload or speed signal overload or external auxiliary voltage U_{AUX} missing
LED AUX		ext. auxiliary voltage U_{AUX} ; dual LED green/red green: voltage OK red: reverse voltage
LED IN		switching state (input); 2 LED yellow
LED FUSE		Motor power supply; 2 green LEDs
LED DIR		Motor rotation direction; yellow LED
LED MOT		Motor active; 2 yellow LEDs
Electrical specifications		
Auxiliary voltage (output)	U_{AUX}	36 ... 56 V DC PELV
Rated operating voltage	U_e	26.5 ... 31.6 V from AS-Interface
Rated operating current	I_e	≤ 25 mA (without sensors) / max. 170 mA
Input		
Number/Type		2 Inputs for 3-wire sensors (PNP), DC
Supply		from AS-Interface
Current loading capacity		100 mA , overload and short-circuit protected
Input current		≤ 6 mA (internally limited)
Switching point		according to DIN EN 61131-2 0 (undamped) ≤ 0.5 mA 1 (damped) ≥ 2.0 mA
Signal delay		< 1 ms (input/AS-Interface)
Input filter		2 ms
Output		
Number/Type		2 outputs for DC roller motors (MOT1, MOT2)
Supply		from external auxiliary voltage U_{AUX}
Current		3.5 A continuous current , 5 A (<2 s) , max. 7.5 A (<0,3 s) per motor
Overload protection		Fuse 4 A, $I^2t = 122.5 A^2s$ per motor
Velocity signal	U_s	0 ... 10 V DC Control via parameter P1:0
Rotation direction signal	U_D	PNP digital output low: high impedance high: ≥ 15 V
Motor fault		NPN digital input 0 (no error) ≥ 125 μA 1 (error) ≤ 25 μA
Directive conformity		
Electromagnetic compatibility		
Directive 2014/30/EU		EN 62026-2:2013+A1:2019
Standard conformity		
Degree of protection		EN 60529:2000
Fieldbus standard		EN 62026-2:2013

Release date: 2023-09-26 Date of issue: 2023-09-26 Filename: 70145537_eng.pdf

Refer to "General Notes Relating to Pepperl+Fuchs Product Information".

 Pepperl+Fuchs Group
www.pepperl-fuchs.com

 USA: +1 330 486 0001
fa-info@us.pepperl-fuchs.com

 Germany: +49 621 776 1111
fa-info@de.pepperl-fuchs.com

 Singapore: +65 6779 9091
fa-info@sg.pepperl-fuchs.com

 **PEPPERL+FUCHS**

Technical Data

Input	EN 61131-2:2007
Emitted interference	EN 61000-6-4:2007 , EN 55011:2016+A1:2017+A11:2020
AS-Interface	EN 62026-2:2013+A1:2019
Noise immunity	EN 61000-6-2:2019 , EN 61326-1:2021 , EN 62026-2:2013+A1:2019
Ambient conditions	
Ambient temperature	-25 ... 65 °C (-13 ... 149 °F)
Storage temperature	-25 ... 85 °C (-13 ... 185 °F)
Relative humidity	85 % non-condensing
Climatic conditions	For indoor use only
Altitude	≤ 5000 m above MSL
Shock and impact resistance	30 g, 11 ms in 6 spatial directions, 3 shocks
Vibration resistance	0.35 mm / 2 g 10 ... 1000 Hz
Pollution degree	2
Mechanical specifications	
Degree of protection	IP54 according to EN 60529
Connection	AS-Interface, AUX: Insulation piercing technology Yellow flat cable/black flat cable Inputs/outputs: M8 round plug connector in accordance with EN 61076-2-104 Inputs: LF004-GS1-A (4-pin, bushing contacts, screw lock, A-coded) Matching connector: LM004-Gx1-A or similar Outputs: NF005-SS1-B (5-pin, bushing contacts, snap lock, B-coded). Matching connector: NM005-Sx1-B or similar
Mass	310 g
Dimensions	
Height	27.5 mm
Width	131.5 mm
Length	54 mm
Mounting	2 clips with Ø 8 mm drill hole
Cable length	1 m
Note	The flat cable routing is designed for 100 actuation cycles

Connection

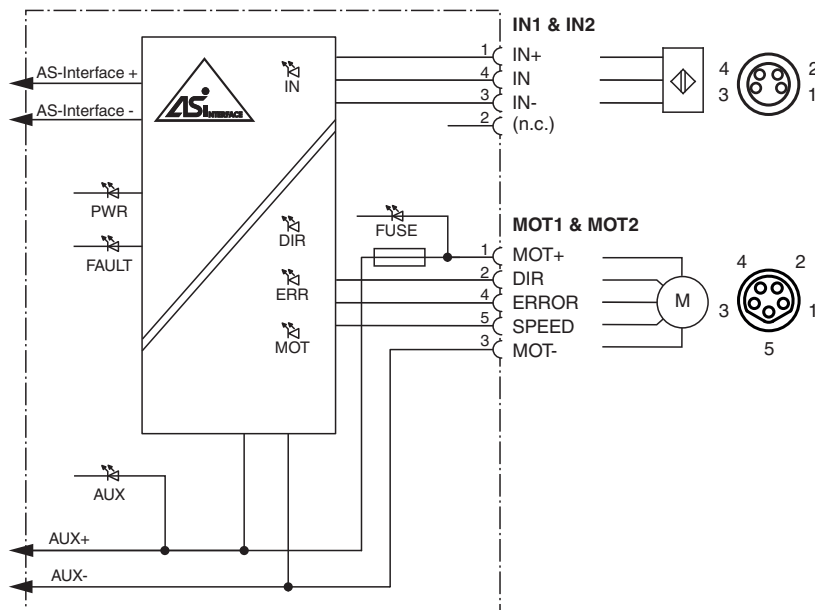

Release date: 2023-09-26 Date of issue: 2023-09-26 Filename: 70145537_eng.pdf

Refer to "General Notes Relating to Pepperl+Fuchs Product Information".

Pepperl+Fuchs Group
www.pepperl-fuchs.com

USA: +1 330 486 0001
fa-info@us.pepperl-fuchs.com

Germany: +49 621 776 1111
fa-info@de.pepperl-fuchs.com

Singapore: +65 6779 9091
fa-info@sg.pepperl-fuchs.com

PF PEPPERL+FUCHS

Assembly

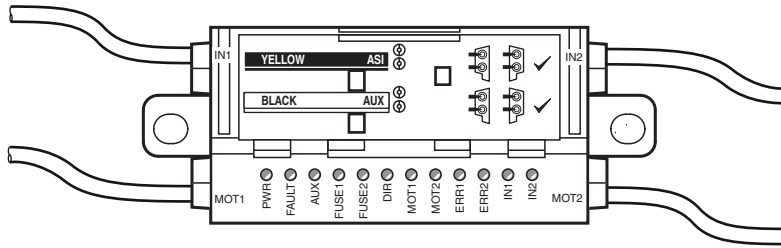

Programming

Data bits

(function via AS-Interface)

Data bits	Input	Output
D0	IN1	MOT1 operation
D1	IN2	MOT2 operation
D2	MOT1 fault	MOT1/MOT2 direction of rotation
D3	MOT2 fault	MOT1/MOT2 slow

Parameter bit

(programmable via AS-Interface)

P1	P0	D0/D1	Speed signal U_s	
			fast (D3=0)	slow (D3=1)
x	x	0	< 1 V	< 1 V
0	0	1	6,44 V	3,96 V
0	1	1	7,26 V	4,28 V
1	0	1	8,5 V	4,78 V
1	1	1	10 V; default setting	5,81 V

P2	MOT1/MOT2 direction of rotation
1	synchronized; default setting
0	counter-rotating; direction of rotation MOT2 inverted

Start/Stop ramp

8 ramps can be configured by AS-Interface parameters/data sequence.

Incline

Constant, independent of terminal velocity.

The ramp duration defines the time from stationary to max. speed ($U_s = 10$ V) or from max. speed to stationary. When the terminal velocity is lower, the ramp duration is shorter.

Ramp no.	Ramp duration
0	No Ramp; default setting
1	50 ms
2	100 ms
3	200 ms
4	300 ms
5	500 ms
6	1000 ms
7	1500 ms

Ramp configuration

Non-volatile

Time frame

10 s after setting D-OUT=4

Hold time

Data/parameters: 10 ms per step

Display

Configuration mode activated: Two LEDs, MOT1 and MOT2, flash

Step	P2:0	D3:0-OUT	D3:0-IN	Comment
1	3	4	x	
2	1	4	x	

Programming

Step	P2:0	D3:0-OUT	D3:0-IN	Comment
3	6	4	x	
4	3	4	x	
5	1	4	x	
6	6	4	11xx = C...F	Configuration mode activated
7	6	Ramp no.	11xx = C...F	Ramp no. 0 ... 7 (see above)
8	4	Ramp no.	10xx = 8...B	Ramp no. stored in non-volatile memory
9	7	0	x	Normal operation





Troubleshooting

If an error occurs in the defined sequence of parameter or data values during steps 1 to 6, the module remains in normal operation.

If an error occurs in steps 7 or 8, the module outputs the value D-IN = 01xx = 4...7 and waits until P = 7 and D-OUT = 0 is set before it returns to normal operation.

If P = 7 and D-OUT = 0 is already set in step 7 or 8, the module switches to normal operation immediately without the output D-IN = 01xx = 4...7. The stored ramp is not changed.

Accessories

	VBP-HH1-V3.0-KIT	AS-Interface Handheld with accessory
	VAZ-PK/G20-1M-V1-G	Adapter cable G20 module/hand-held programming device
	VAZ-G20-MH	Mounting aid
	VAZ-G10-LIMITER	Voltage limiter G10