

Female cordset

V11-W-BK15M-PVC-U



- Degree of protection IP68 / IP69
- UL listed for USA and Canada
- Specific design protects against loosening and inaccurate installation

Female cordset single-ended M12 angled A-coded, 3-pin, PVC cable black, UL approved



Dimensions

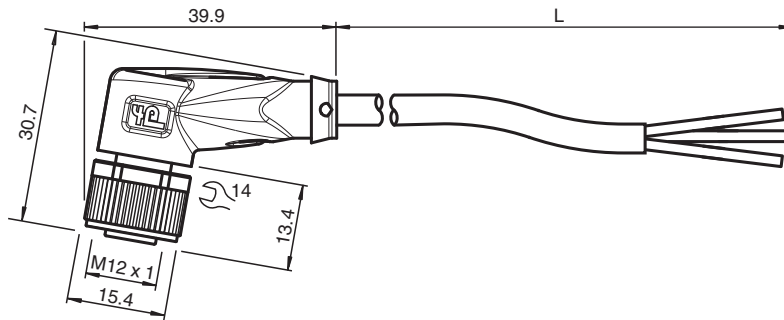

Technical Data

General specifications

| | |
|--------------------|------------------|
| Connector 1 | |
| Connection | socket |
| Construction type | M12 |
| Style | angled |
| Locking | screw connection |
| Number of pins | 3 |
| Coding | A-coded |
| Connector 2 | |
| Connection | cable end |

Electrical specifications

| | | |
|-------------------|-------|------------------|
| Operating voltage | U_B | max. 250 V AC/DC |
| Operating current | I_B | max. 4 A |

Conformity

| | |
|----------------------|-------------------------------------|
| Degree of protection | EN 60529 |
| Plug connection | connector M12 x 1 : IEC 61076-2-101 |
| Flammability | UL 1581 , IEC 60332-1-2 |

Approvals and certificates

| | |
|----------------|---|
| UL approval | AWM STYLE 2095 AWM I/II A/B 80°C 300V FT1 (cable) |
| UL File Number | E231213 |

Ambient conditions

Release date: 2023-09-04 Date of issue: 2023-09-04 Filename: 239999-0040_eng.pdf

Refer to "General Notes Relating to Pepperl+Fuchs Product Information".

Pepperl+Fuchs Group
www.pepperl-fuchs.com

USA: +1 330 486 0001
fa-info@us.pepperl-fuchs.com

Germany: +49 621 776 1111
fa-info@de.pepperl-fuchs.com

Singapore: +65 6779 9091
fa-info@sg.pepperl-fuchs.com

PEPPERL+FUCHS

Technical Data

| | | |
|----------------------------------|---|--|
| Ambient temperature | | |
| Plug connector | | -40 ... 90 °C (-40 ... 194 °F) |
| Cable, fixed | | -25 ... 80 °C (-13 ... 176 °F) |
| Cable, flexing | | -5 ... 80 °C (23 ... 176 °F) |
| Pollution degree | | 3 |
| Mechanical specifications | | |
| Plug connector | | |
| Tightening torque | | 0.6 Nm |
| Loosening protection | | available |
| Tool installation | | straight knurling and hexagon nut SW = 14 mm |
| Mating cycles | | min. 100 |
| Degree of protection | | IP68 / IP69 |
| Cable | | |
| Sheath diameter | | 4.3 mm |
| Bending radius | | > 15 x cable diameter, moving > 5 x cable diameter, fixed |
| Sheath stripping force | | max. 50 N / 300 mm |
| Sheath color | | black (similar to RAL 9005) |
| Number of cores | | 3 |
| Core cross section | | 0.34 mm ² |
| Cores color | | Core 1: brown Core 3: blue Core 4: black |
| Core construction | | 19 x 0.15 mm Ø |
| Length | L | 15 m |
| Cable code | | Li YY 3 x 0,34 |
| Material | | |
| Plug connector | | |
| Screw connection | | Zinc diecast, nickel-plated |
| Body | | TPU, black |
| Seal | | FKM |
| Contact surface | | gold plated (Au) |
| Flammability | | V-2 |
| Cable | | |
| Sheathing | | PVC |
| Core insulation | | PVC |
| Flammability | | FT1 |



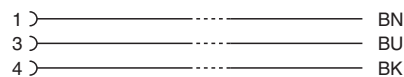
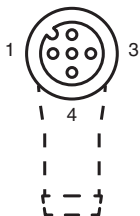



Connection



Accessories

| | | |
|---|--------------------------|-----------------------------|
|  | MH V1-SCREWDRIVER | Torque screwdriver (0.6 Nm) |
|---|--------------------------|-----------------------------|

Accessories

| | | |
|---|------------------------------|--|
|  | MH V1-BIT M12 | plug-in cap M12 |
|  | V1/V3-LABELHOLDER | Label holder |
|  | V1/V3-LABEL | Label plate |
|  | MH V1-Holder | Modular universal holder for M12 connectors |
|  | V1-CLIP | Unlocking protector for M12 connector |
|  | V1-MARKING-RING-COLOR | Marking rings for M12 connectors, various colors |