



Triangulation sensor (BGS)

OBT1250-R202-E4



- Medium design with versatile mounting options
- Degree of protection IP67
- Mounting on full metal sockets
- Very bright, highly visible light spot
- Highly visible LEDs for Power ON and switching state
- Easy to use
- Image is generic for this device type and may deviate from the specific variant



Function

The optical sensors of this series for applications in standard automation have a modern housing design. The sensors are characterized by the many mounting options, easy handling and highly visible LED status indicators. The integrated full metal bushings ensure long-term secure and dimensionally stable mounting.

Dimensions

Drawing is generic for this device type and may deviate from the specific variant.
For the number of cores refer to connection diagram.

Dimensions

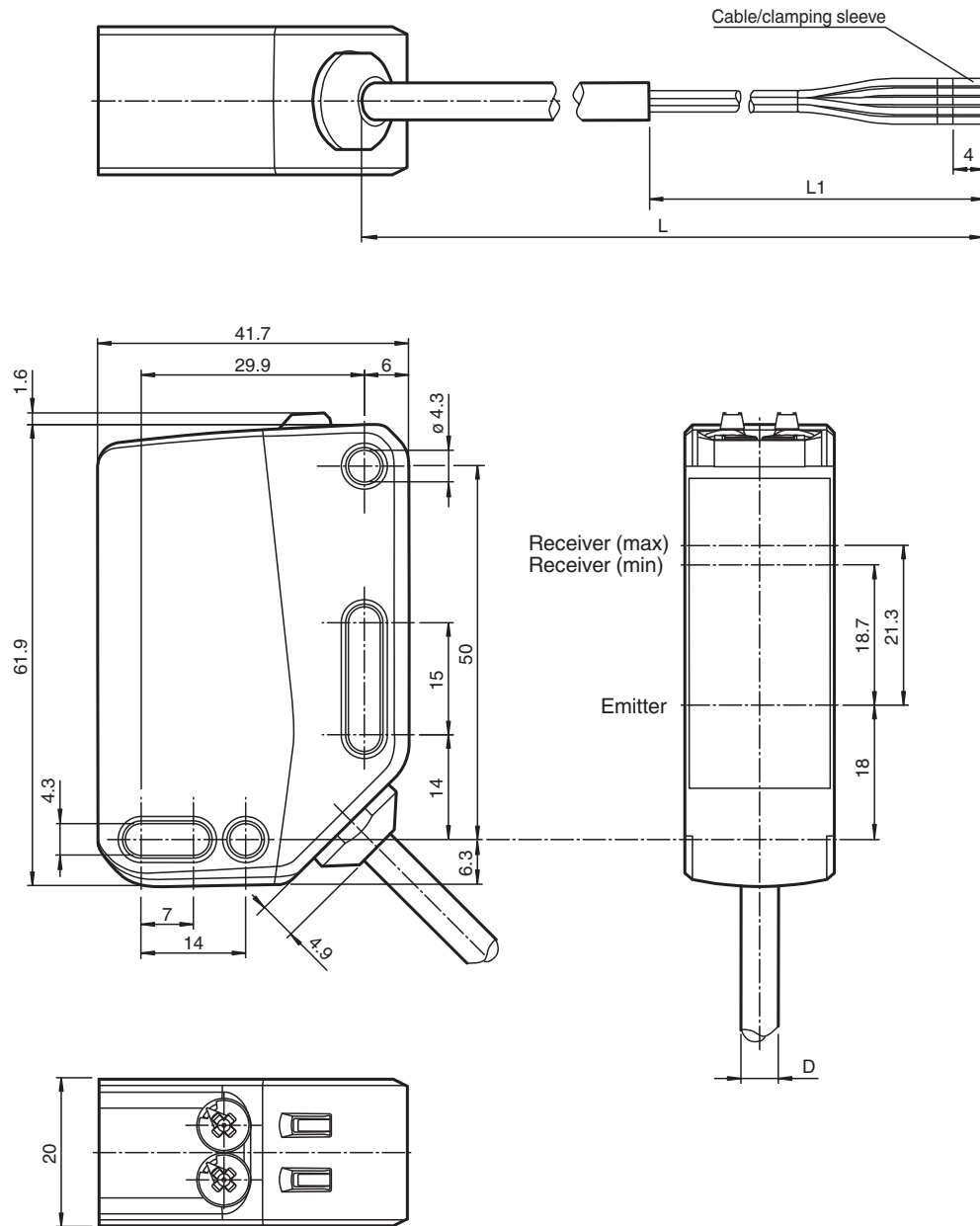

Technical Data

General specifications

Detection range	0 ... 1250 mm
Detection range min.	0 ... 200 mm
Detection range max.	0 ... 1250 mm
Adjustment range	200 ... 1250 mm
Reference target	standard white, 100 mm x 100 mm
Light source	LED
Light type	modulated visible red light

Release date: 2023-07-11 Date of issue: 2023-07-11 Filename: 70128080-100049_eng.pdf

Refer to "General Notes Relating to Pepperl+Fuchs Product Information".

Pepperl+Fuchs Group
www.pepperl-fuchs.com

USA: +1 330 486 0001
fa-info@us.pepperl-fuchs.com

Germany: +49 621 776 1111
fa-info@de.pepperl-fuchs.com

Singapore: +65 6779 9091
fa-info@sg.pepperl-fuchs.com

PF PEPPERL+FUCHS

Technical Data

LED risk group labelling		exempt group
Black-white difference (6 %/90 %)		< 40 % at 1250 mm
Diameter of the light spot		approx. 50 mm at a distance of 1250 mm
Opening angle		3 °
Ambient light limit		EN 60947-5-2 : 30000 Lux
Functional safety related parameters		
MTTF _d		876 a
Mission Time (T _M)		20 a
Diagnostic Coverage (DC)		0 %
Indicators/operating means		
Operation indicator		LED green: on - power on flashing (4 Hz) - short circuit
Function indicator		LED yellow: constantly on - object detected constantly off - object not detected Flashing (8 Hz) - fault detected, the outputs maintain the status
Control elements		Light-on/dark-on changeover switch
Control elements		Sensing range adjuster
Electrical specifications		
Operating voltage	U _B	10 ... 30 V DC
Ripple		max. 10 %
No-load supply current	I ₀	< 35 mA at 24 V Operating voltage
Protection class		III
Output		
Switching type		The switching type of the sensor is adjustable. The default setting is: Q - Pin4: NPN normally open / light-on
Signal output		1 NPN, short-circuit protected, reverse polarity protected
Switching voltage		max. 30 V DC
Switching current		max. 100 mA , resistive load
Usage category		DC-12 and DC-13
Voltage drop	U _d	≤ 1.5 V DC
Switching frequency	f	1000 Hz
Response time		0.5 ms
Conformity		
Product standard		EN 60947-5-2
Approvals and certificates		
UL approval		E87056 , cULus Listed , class 2 power supply , type rating 1
CCC approval		CCC approval / marking not required for products rated ≤36 V
Ambient conditions		
Ambient temperature		-30 ... 60 °C (-22 ... 140 °F)
Storage temperature		-40 ... 70 °C (-40 ... 158 °F)
Mechanical specifications		
Housing width		20 mm
Housing height		62 mm
Housing depth		42 mm
Degree of protection		IP67
Connection		2 m fixed cable
Material		
Housing		PC (Polycarbonate)
Optical face		PMMA
Mass		approx. 100 g
Cable length		2 m

Release date: 2023-07-11 Date of issue: 2023-07-11 Filename: 70128080-100049_eng.pdf

Connection

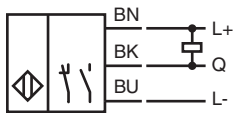

Assembly

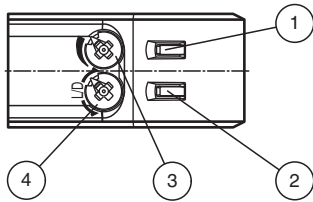

1	Function indicator	YE
2	Operation indicator	GN
3	Sensitivity adjuster	
4	Light-on / dark-on changeover switch	

Characteristic Curve

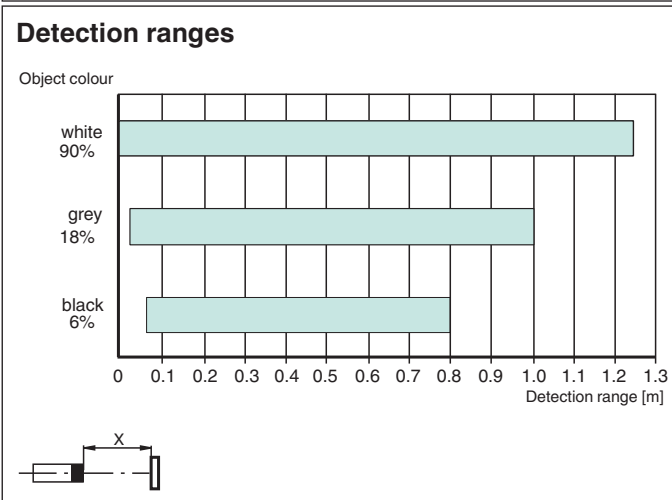
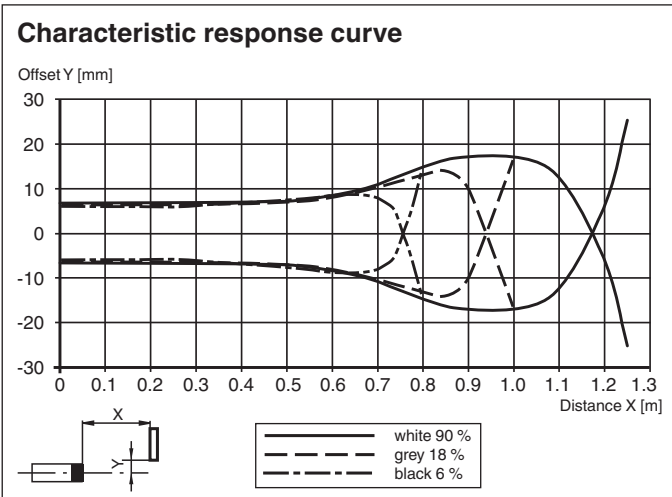

Release date: 2023-07-11 Date of issue: 2023-07-11 Filename: 70128080-100049_eng.pdf

Characteristic Curve

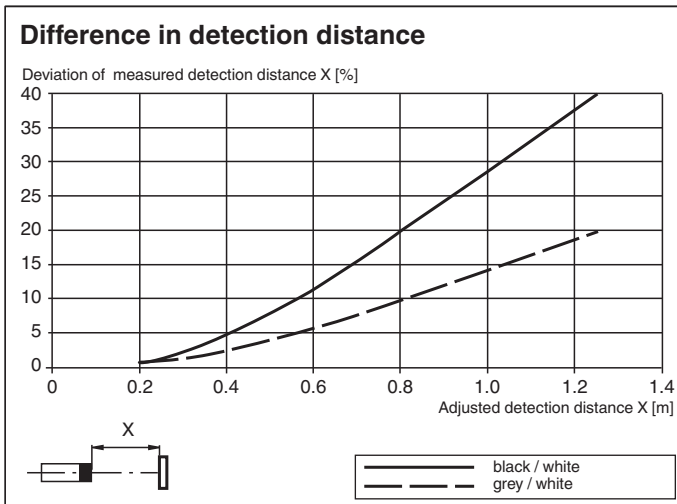

Commissioning

Sensing Range / Sensitivity



Turn sensing range / sensitivity adjuster clockwise to increase sensing range / sensitivity.
 Turn sensing range / sensitivity adjuster counter clockwise to decrease sensing range / sensitivity.
 The internal end stop signals the end of the adjustment range.

Light-on / Dark-on Configuration

To set light switching or dark switching, turn the light/dark changeover switch to the end stop:

- clockwise: dark switching
- counterclockwise: light switching

Accessories

	OMH-RL31-02	Mounting bracket narrow
	OMH-R202-02	Mounting aid for round steel ø 12 mm or sheet 1.5 mm ... 3 mm
	OMH-R202-01	Mounting aid for round steel ø 12 mm or sheet 1.5 mm ... 3 mm