

Ultrasonic sensor

UC2000-30GM-2EP-IO-V15

- IO-Link interface for service and process data
- Programmable via DTM with PACTWARE
- 2 programmable switch outputs
- Selectable sound lobe width
- Synchronization options
- Temperature compensation

Single head system



Dimensions

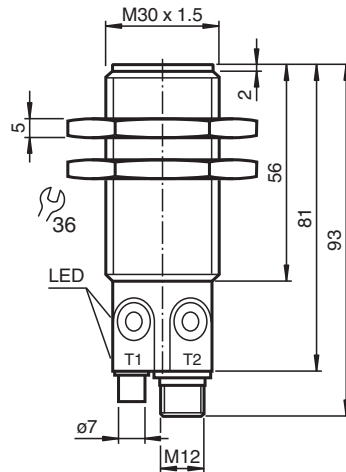

Technical Data

General specifications	
Sensing range	90 ... 2000 mm
Adjustment range	120 ... 2000 mm
Dead band	0 ... 90 mm
Standard target plate	100 mm x 100 mm
Transducer frequency	approx. 200 kHz
Response delay	minimum : 65 ms factory setting: 125 ms
Memory	
Non-volatile memory	EEPROM

Release date: 2023-09-01 Date of issue: 2023-09-01 Filename: 191243_eng.pdf

Refer to "General Notes Relating to Pepperl+Fuchs Product Information".

Pepperl+Fuchs Group
www.pepperl-fuchs.com

USA: +1 330 486 0001
fa-info@us.pepperl-fuchs.com

Germany: +49 621 776 1111
fa-info@de.pepperl-fuchs.com

Singapore: +65 6779 9091
fa-info@sg.pepperl-fuchs.com

PF PEPPERL+FUCHS

Technical Data

Write cycles		100000
Indicators/operating means		
LED green		solid: Power on flashing: Standby mode or IO link communication
LED yellow 1		solid: Object in evaluation range flashing: Learning function, object detected
LED yellow 2		solid: Object in evaluation range flashing: Learning function, object detected
LED red		solid red: Error red, flashing: program function, object not detected
Electrical specifications		
Operating voltage	U_B	10 ... 30 V DC , ripple 10 % _{SS}
No-load supply current	I_0	≤ 60 mA
Power consumption	P_0	≤ 1 W
Time delay before availability	t_v	≤ 120 ms
Interface		
Interface type		IO-Link
Protocol		IO-Link V1.0
Transfer rate		Acyclical: typical 95 Bit/s
Cycle time		min. 33.6 ms
Mode		COM2 (38.4 kBit/s)
Process data width		16 bit
SIO mode support		yes
Input/Output		
Input/output type		1 synchronization connection, bidirectional
0 Level		0 ... 1 V
1 Level		4 V ... U_B
Input impedance		> 12 kΩ
Output rated operating current		< 12 mA
Pulse length		0.5 ... 300 ms (level 1)
Pulse interval		≥ 33 ms (level 0)
Synchronization frequency		
Common mode operation		≤ 30 Hz
Multiplex operation		≤ 33 Hz / n , n = number of sensors , n ≤ 10 (factory setting: n = 5)
Output		
Output type		2 push-pull (4 in 1) outputs, short-circuit protected, reverse polarity protected
Rated operating current	I_e	200 mA , short-circuit/overload protected
Voltage drop	U_d	≤ 2.5 V
Repeat accuracy		≤ 0.1 % of full-scale value
Switching frequency	f	≤ 4 Hz
Range hysteresis	H	1 % of the adjusted operating range (default settings), programmable
Temperature influence		≤ 1.5 % from full-scale value (with temperature compensation) ≤ 0.2 %/K (without temperature compensation)
Compliance with standards and directives		
Standard conformity		
Standards		EN IEC 60947-5-2:2020 IEC 60947-5-2:2019
Approvals and certificates		
UL approval		cULus Listed, Class 2 Power Source
CCC approval		CCC approval / marking not required for products rated ≤36 V
Ambient conditions		
Ambient temperature		-25 ... 70 °C (-13 ... 158 °F)
Storage temperature		-40 ... 85 °C (-40 ... 185 °F)
Mechanical specifications		
Connection type		Connector plug M12 x 1 , 5-pin

Release date: 2023-09-01 Date of issue: 2023-09-01 Filename: 191243_eng.pdf

Refer to "General Notes Relating to Pepperl+Fuchs Product Information".

 Pepperl+Fuchs Group
www.pepperl-fuchs.com

 USA: +1 330 486 0001
fa-info@us.pepperl-fuchs.com

 Germany: +49 621 776 1111
fa-info@de.pepperl-fuchs.com

 Singapore: +65 6779 9091
fa-info@sg.pepperl-fuchs.com

 **PEPPERL+FUCHS**

Technical Data

Housing diameter	30 mm
Degree of protection	IP67
Material	
Housing	Stainless steel 1.4305 / AISI 303 TPU Polyamides
Transducer	epoxy resin/hollow glass sphere mixture; polyurethane foam
Mass	72 g
Factory settings	
Output 1	near switch point: 120 mm far switch point: 2000 mm output function: Window mode output behavior: NO contact
Output 2	near switch point: 120 mm far switch point: 1000 mm output function: Window mode output behavior: NO contact
Beam width	wide

Connection

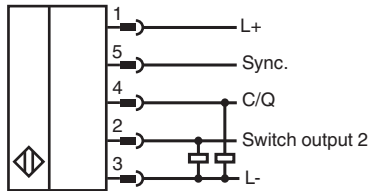

Connection Assignment

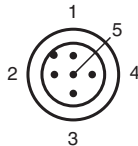

Wire colors in accordance with EN 60947-5-2

1	BN	(brown)
2	WH	(white)
3	BU	(blue)
4	BK	(black)
5	GY	(gray)

Release date: 2023-09-01 Date of issue: 2023-09-01 Filename: 191243_eng.pdf

Characteristic Curve

Characteristic response curve

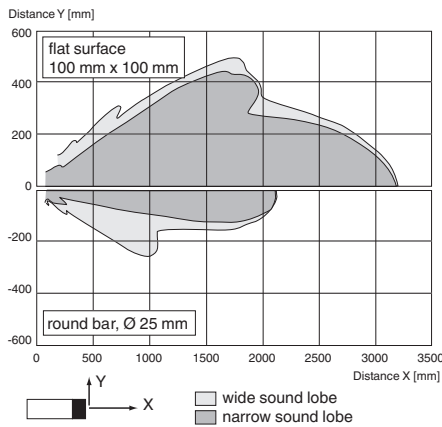

Switching output operating modes

1. Switching point mode

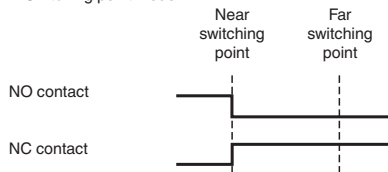

2. Window mode

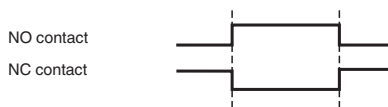





3. Hysteresis mode

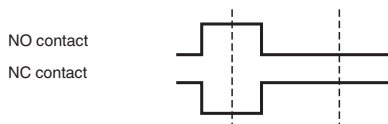

4. Retroreflective sensor mode















Accessories

	BF 30	Mounting flange, 30 mm
	BF 30-F	Plastic mounting adapter, 30 mm
	BF 5-30	Universal mounting bracket for cylindrical sensors with a diameter of 5 ... 30 mm
	V15-W-2M-PVC	Female cordset single-ended M12 angled A-coded, 5-pin, PVC cable grey
	UVW90-M30	Ultrasonic -deflector

Release date: 2023-09-01 Date of issue: 2023-09-01 Filename: 191243_eng.pdf

Accessories

	UVW90-K30	Ultrasonic -deflector
	M30K-VE	Plastic nuts with centering ring for the vibration-free mounting of cylindrical sensors
	V15-G-2M-PVC	Female cordset single-ended M12 straight A-coded, 5-pin, PVC cable grey
	V15-W-2M-PUR	Female cordset single-ended M12 angled A-coded, 5-pin, PUR cable grey
	ICE2-8IOL-G65L-V1D	EtherNet/IP IO-Link master with 8 inputs/outputs
	ICE3-8IOL-G65L-V1D	PROFINET IO IO-Link master with 8 inputs/outputs
	ICE1-8IOL-G30L-V1D	Ethernet IO-Link module with 8 inputs/outputs
	ICE1-8IOL-G60L-V1D	Ethernet IO-Link module with 8 inputs/outputs
	ICE2-8IOL-K45P-RJ45	EtherNet/IP IO-Link master with 8 inputs/outputs, DIN rail, push-in connectors
	ICE2-8IOL-K45S-RJ45	EtherNet/IP IO-Link master with 8 inputs/outputs, DIN rail, screw terminal
	ICE3-8IOL-K45P-RJ45	PROFINET IO IO-Link master with 8 inputs/outputs, DIN rail, push-in terminals
	ICE3-8IOL-K45S-RJ45	PROFINET IO IO-Link master with 8 inputs/outputs, DIN rail, screw terminal
	IO-Link-Master02-USB	IO-Link master, supply via USB port or separate power supply, LED indicators, M12 plug for sensor connection

Release date: 2023-09-01 Date of issue: 2023-09-01 Filename: 191243_eng.pdf

Programming

Programming

The sensor is equipped with two outputs. Two switching points or trip values as well as the output mode, can be programmed for each output. The shape of the sensor sound cone can also be programmed. These parameters can be configured using two different methods:

- Using the sensor push buttons
- Using the IO-link interface of the sensor. This method requires an IO-link master (e.g. IO-link master01 USB) and the associated software. The download link is available on the product page for the sensor with the IO link at www.pepperl-fuchs.de

Configuration using the push buttons is described below. To configure the parameters using the sensor IO-link interface, please read the software description. The processes for configuring the switching points and the sensor operating modes run completely independently and do not influence one another.

Note:

- The sensor can only be programmed during the first 5 minutes after switching on. This time is extended during the actual programming process. The option of programming the sensor is revoked if no programming activities take place for 5 minutes. After this, programming is no longer possible until the sensor is switched off and on again.
- The programming activities can be canceled at any time without changing the sensor settings. To do so, press and hold the push button for 10 seconds.

Programming the switch points

Note:

Each push button is assigned to a physical output. Switching output 1 (C/Q) is programmed via push button T1. Switching output 2 is programmed via push button T2. The status of switching output 1 is indicated by the yellow LED L1. The status of switching output 2 is indicated by the yellow LED L2.

Programming the near switch point

1. Position the object at the site of the required near switch point.
2. Press and hold the push button for 2 seconds (yellow LED flashes).
3. Briefly press the push button (green LED flashes 3 times as confirmation). The sensor returns to normal mode.

Programming the distant switch point

1. Position the object at the site of the required distant switch point
2. Press and hold the push button for 2 seconds (yellow LED flashes)
3. Press and hold the push button for 2 seconds (green LED flashes 3 times as confirmation). The sensor returns to normal mode.

Programming the operating mode

The sensor features a 3-stage process for programming the sensor operating modes. You can program the following with this process:

1. Output function
2. Output behavior of the switching output
3. The beam width

These 3 stages of the process are programmed in succession. To switch from one programming function to the next, press and hold the push button for 2 seconds.

Accessing the programming routine

The operating mode can be programmed separately for each of the two switching outputs. The switching output 1 (C/Q) operating mode is programmed via push button T1. The switching output 2 operating mode is programmed via push button T2. To access the programming routine for the sensor operating mode, press the push button for 5 seconds.

Programming the output function of the switching output

The green LED is now flashing. The number of flashes indicates the output function currently programmed:

- 1x: Switching point mode
- 2x: Window mode
- 3x: Hysteresis mode
- 4x: Reflective mode

1. Briefly press the push button to navigate through the output functions in succession. Use this method to choose the required output function.
2. Press and hold the push button for 2 seconds to save the selection and switch to the programming routine for the output behavior.

Programming the output behavior for the switching output

The yellow LED is now flashing. The number of flashes indicates the output behavior currently programmed:

- 1x: NO contact
- 2x: NC contact

1. Briefly press the push button to switch between the possible output behaviors in succession. Use this method to choose the output behavior.
2. Press and hold the push button for 2 seconds to save the selection and switch to the programming routine for the sound cone.

Programming the beam width

The red LED is now flashing. The number of flashes indicates the beam width currently programmed:

- 1x: narrow
- 2x: medium
- 3x: wide

1. Briefly press the push button to navigate through the different beam widths in succession. Use this method to choose the required beam width.
2. Press and hold the push button for 2 seconds to return to normal operation mode.

Note

The last beam width programmed applies for both outputs in equal measure.

Factory Setting

Resetting the sensor to the factory settings

The sensor can be reset to the original factory settings.

1. Disconnect the sensor from the power supply
 2. Press and hold one of the push buttons
 3. Connect the power supply (yellow and red LEDs flash simultaneously for 5 seconds, followed by the yellow and green LEDs flashing simultaneously)
 4. Release the push button
- The sensor will now function with the original factory settings.

Factory settings

See technical data.

Indication

Indicators

The sensor has four LEDs for indicating the status and two buttons for setting parameters.

	LED, green	LED L1, yellow	LED L2, yellow	LED, red
In normal mode Error-free operation Fault (e.g. compressed air)	On Off	The output status retains the last status	The output status retains the last status	Off On
When programming the switching points or trip values Object detected No object detected Confirmation, programming successful Warning, programming invalid	Off Off Flashes 3x Off	Flashes Off Off Off	Flashes Off Off Off	Off Flashes Off Flashes 3x
When programming the operating mode Programming the output mode Programming the output behavior Programming the sound cone	Flashes Off Off	Off Flashes Off	Off Flashes Off	Off Off Flashes

Commissioning

Synchronization

The sensor is fitted with a synchronization input that suppresses mutual interference from external ultrasonic signals. If this input is not connected, the sensor operates with internally generated cycle pulses. The sensor can be synchronized by creating external rectangular pulses and by setting the appropriate parameters via the IO-link interface. Each falling pulse edge sends an individual ultrasonic pulse. If the signal at the synchronization input is low for ≥ 1 second, the sensor reverts to the normal, unsynchronized operating mode. This also occurs if the synchronization input is disconnected from external signals (see note below).

If a high signal is applied to the synchronization input for > 1 second, the sensor switches to standby. This is indicated by the green LED. In this operating mode, the last recorded output statuses are retained. Please observe the software description in the event of external synchronization.

Note:

- If the option of synchronizing is not used, the synchronization input must be connected to ground (L-) or the sensor must be operated with a V1-connection cable (4-pin).
- During an active IO-Link communication the synchronization option is not available.

The following synchronization modes are available:

1. Multiple sensors (see Technical data for the maximum number) can be synchronized by connecting the synchronization inputs on the sensors. In this case, the sensors synchronize themselves in succession in multiplex mode. Only one sensor sends signals at any one time. (See note below)
2. Multiple sensors (see Technical data for the maximum number) can be synchronized by connecting the synchronization inputs on the sensors. The sensor interface can be used to parameterize the sensors so that one functions as a master and the others function as slaves. (See interface description) In this case, the sensors in master/slave mode work simultaneously, i.e. in synchronization where the master sensor plays the role of an intelligent external impulse generator.

Release date: 2023-09-01 Date of issue: 2023-09-01 Filename: 191243_eng.pdf

Refer to "General Notes Relating to Pepperl+Fuchs Product Information".

- Multiple sensors can be controlled collectively by an external signal. In this case, the sensors are triggered in parallel and operate synchronously, i.e. at the same time. All sensors must be parameterized via the sensor interface so that they are set to external. See the software description.
- Several sensors are controlled with a time delay by an external signal. In this case, only one sensor is externally synchronized at any one time (see note below). All sensors must be parameterized via the sensor interface so that they are set to external. See the software description.
- A high signal (L+) or a low signal (L-) at the synchronization input switches the sensor to standby in the case of external parameterization.

Note:

The response time of the sensors increases in proportion to the number of sensors in the synchronization chain. In multiplex mode, the measuring cycles of the individual sensors run in succession in a chronological sequence.

Note:

The synchronization connection of the sensors supplies an output current in the case of a low signal, and generates an input impedance in the case of a high signal. Please note that the synchronizing device must have the following driver properties:

Driver current according to $L+ \geq n \cdot \text{high level signal/input impedance}$ (n = number of sensors to be synchronized)

Driver current according to $L- \geq n \cdot \text{output current}$ (n = number of sensors to be synchronized).