

Mounting aid

OMH-ML100-05



- Mounting bracket
- Simple and fast mounting

Mounting aid for ML100 series, Mounting bracket



Dimensions

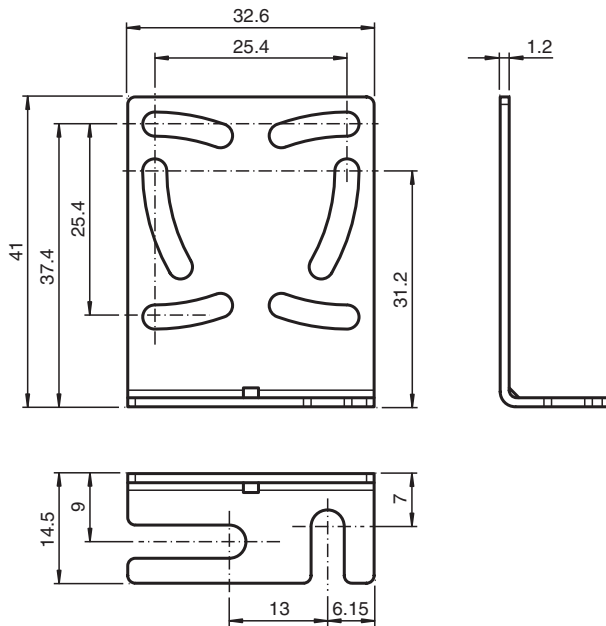

Technical Data

Mechanical specifications

Material	Stainless steel
Mass	approx. 12 g
Mounting	Mounting accessories included
Suitable series	
Series	ML100

Release date: 2020-06-29 Date of issue: 2020-06-30 Filename: 227089_eng.pdf

Refer to "General Notes Relating to Pepperl+Fuchs Product Information".

Pepperl+Fuchs Group
www.pepperl-fuchs.com

USA: +1 330 486 0001
fa-info@us.pepperl-fuchs.com

Germany: +49 621 776 1111
fa-info@de.pepperl-fuchs.com

Singapore: +65 6779 9091
fa-info@sg.pepperl-fuchs.com

PF PEPPERL+FUCHS