



Retroreflective sensor ML100-55/103/115a



- Miniature design
- Easy to use
- Clearly visible LEDs for Power ON, switching state and weak signal indication
- Full metal thread mounting
- Very bright, highly visible light spot
- Not sensitive to ambient light

Retroreflective sensor with polarization filter, plastic housing, 5 m detection range, red light, sensitivity adjuster, light/dark on, DC version, PNP output, fixed cable with M8 plug



Function

The optical sensors of this series are suitable for both standard and demanding applications. The series features a miniature housing design, two M3 metal-threaded mounting holes and a highly visible LED status indicator. Each device is equipped with a sensitivity adjuster and a light-on/dark-on changeover switch for increased flexibility. A wide variety of versions are available in both infrared light and red light with PowerBeam for easy alignment. Special versions with BlueBeam are suitable for challenging applications like those in the solar and battery industries.

Dimensions

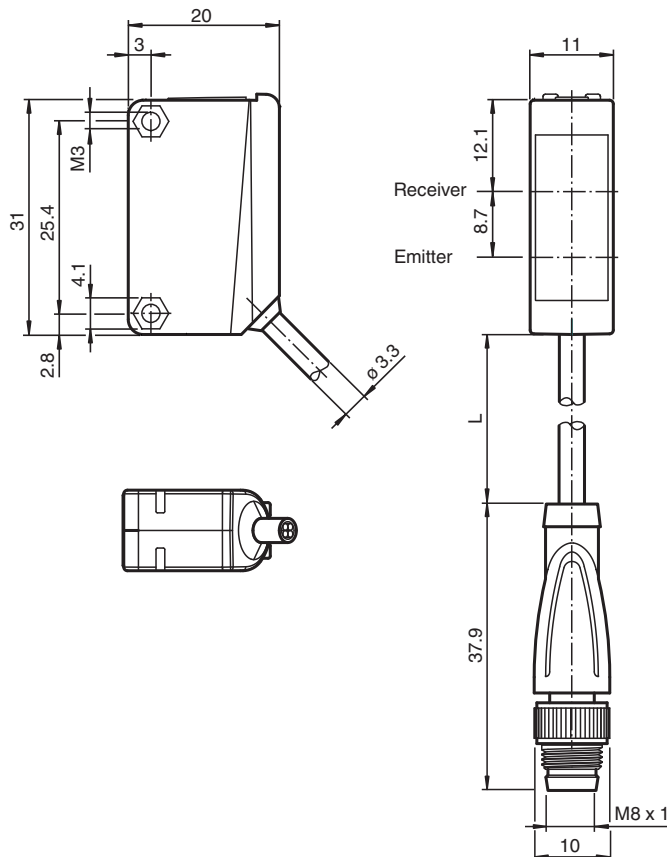

Release date: 2023-04-04 Date of issue: 2023-04-04 Filename: 221826_eng.pdf

Refer to "General Notes Relating to Pepperl+Fuchs Product Information".

Pepperl+Fuchs Group
www.pepperl-fuchs.com

USA: +1 330 486 0001
fa-info@us.pepperl-fuchs.com

Germany: +49 621 776 1111
fa-info@de.pepperl-fuchs.com

Singapore: +65 6779 9091
fa-info@sg.pepperl-fuchs.com

PF PEPPERL+FUCHS

Technical Data

| General specifications | | |
|--------------------------------------|----------------|---|
| Effective detection range | | 0 ... 5 m |
| Reflector distance | | 0.01 ... 5 m |
| Threshold detection range | | 7 m |
| Reference target | | H50 reflector |
| Light source | | LED |
| Light type | | modulated visible red light |
| Polarization filter | | yes |
| Diameter of the light spot | | approx. 500 mm at a distance of 7 m |
| Opening angle | | approx. 4 ° |
| Optical face | | frontal |
| Ambient light limit | | EN 60947-5-2:2007+A1:2012 |
| Functional safety related parameters | | |
| MTTF _d | | 860 a |
| Mission Time (T _M) | | 20 a |
| Diagnostic Coverage (DC) | | 0 % |
| Indicators/operating means | | |
| Operation indicator | | LED green: power on |
| Function indicator | | LED yellow: lights up when receiving the light beam ; flashes when falling short of the operating reserve; OFF when light beam is interrupted |
| Control elements | | sensitivity adjustment |
| Control elements | | Light-on/dark-on changeover switch |
| Electrical specifications | | |
| Operating voltage | U _B | 10 ... 30 V DC |
| Ripple | | max. 10 % |
| No-load supply current | I ₀ | < 20 mA |
| Output | | |
| Switching type | | The switching type of the sensor is adjustable. The default setting is: light-on |
| Signal output | | 1 PNP output, short-circuit protected, reverse polarity protected, open collector |
| Switching voltage | | max. 30 V DC |
| Switching current | | max. 100 mA , resistive load |
| Voltage drop | U _d | ≤ 1.5 V DC |
| Switching frequency | f | 1000 Hz |
| Response time | | 0.5 ms |
| Conformity | | |
| Product standard | | EN 60947-5-2 |
| Approvals and certificates | | |
| UL approval | | cULus Listed, Class 2 Power Source or listed Power Supply with a limited voltage output with (maybe integrated) fuse (max. 3.3 A according UL248), Type 1 enclosure |
| CCC approval | | CCC approval / marking not required for products rated ≤36 V |
| Ambient conditions | | |
| Ambient temperature | | -30 ... 60 °C (-22 ... 140 °F) |
| Storage temperature | | -40 ... 70 °C (-40 ... 158 °F) |
| Mechanical specifications | | |
| Housing width | | 11 mm |
| Housing height | | 31 mm |
| Housing depth | | 20 mm |
| Degree of protection | | IP67 |
| Connection | | 300 mm fixed cable with M8 connector, 4-pin |
| Material | | |
| Housing | | PC (Polycarbonate) |
| Optical face | | PMMA |
| Mass | | approx. 20 g |
| Tightening torque, fastening screws | | 0.6 Nm |

Release date: 2023-04-04 Date of issue: 2023-04-04 Filename: 221826_eng.pdf

Refer to "General Notes Relating to Pepperl+Fuchs Product Information".

Pepperl+Fuchs Group
www.pepperl-fuchs.com

USA: +1 330 486 0001
fa-info@us.pepperl-fuchs.com

Germany: +49 621 776 1111
fa-info@de.pepperl-fuchs.com

Singapore: +65 6779 9091
fa-info@sg.pepperl-fuchs.com

 PEPPERL+FUCHS

Technical Data

| | |
|--------------|-------|
| Cable length | 0.3 m |
|--------------|-------|

Connection

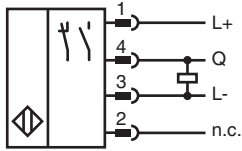

Connection Assignment



Wire colors in accordance with EN 60947-5-2

| | | |
|---|----|---------|
| 1 | BN | (brown) |
| 2 | WH | (white) |
| 3 | BU | (blue) |
| 4 | BK | (black) |

Assembly

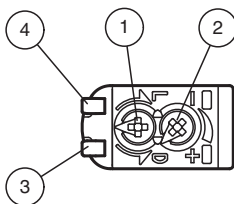

| | | |
|---|----------------------|--------|
| 1 | Light-Dark-switching | |
| 2 | Sensitivity adjuster | |
| 3 | Signal display | yellow |
| 4 | Operating display | green |

Release date: 2023-04-04 Date of issue: 2023-04-04 Filename: 221826_eng.pdf

Characteristic Curve

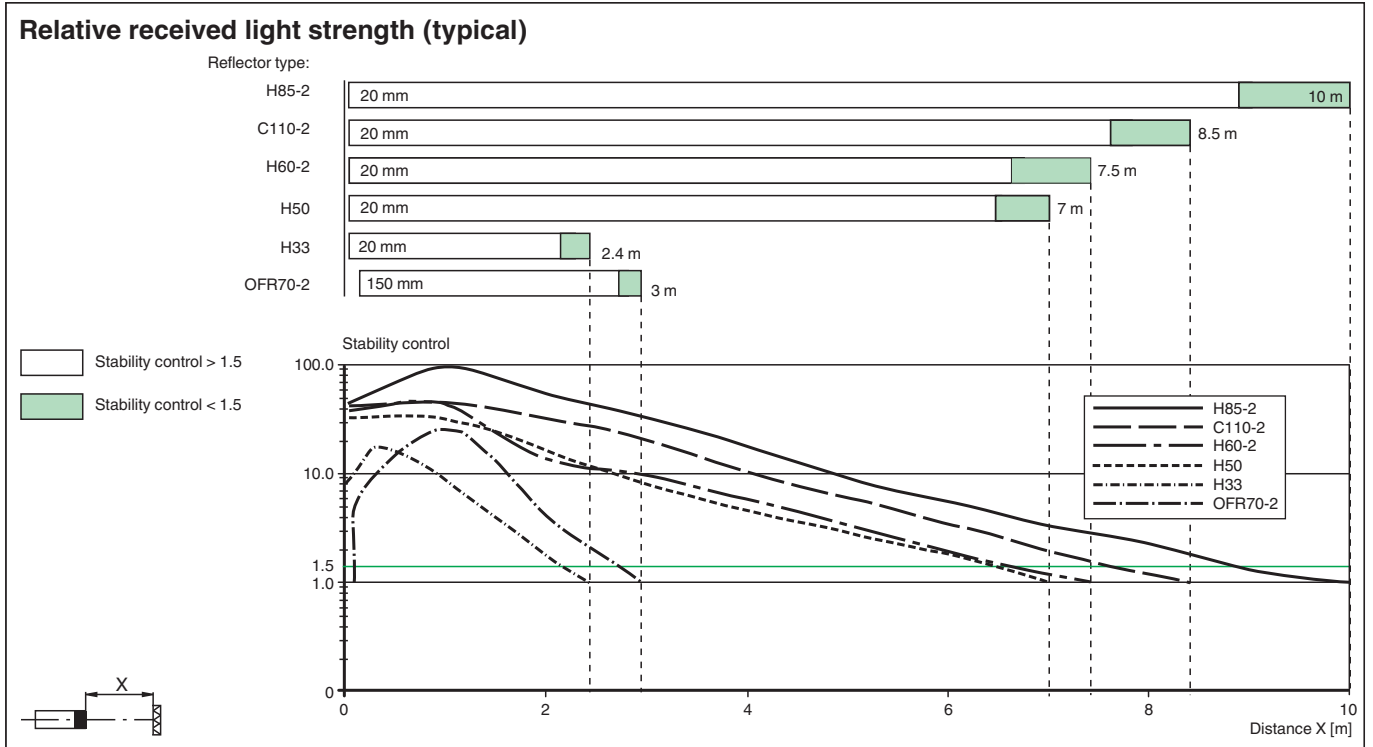
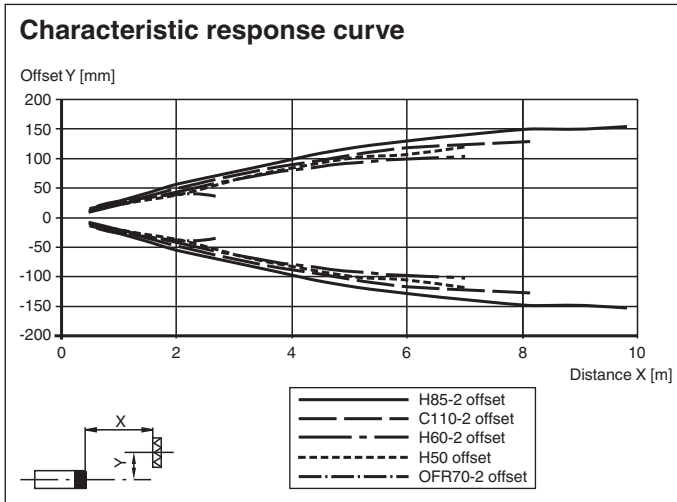













Accessories

| | | |
|--|----------------------|---|
| | OMH-ML100-09 | Mounting aid for round steel \varnothing 12 mm or sheet 1.5 mm ... 3 mm |
| | OMH-F10-ML100 | Mounting aid for ML100 series |
| | OMH-ML100-01 | Mounting aid for ML100 series, mounting bracket |
| | OMH-ML100-02 | Mounting aid for ML100 series, mounting bracket |
| | OMH-ML100-03 | Mounting aid for round steel \varnothing 12 mm or sheet 1.5 mm ... 3 mm |

Release date: 2023-04-04 Date of issue: 2023-04-04 Filename: 221826_eng.pdf

Accessories

| | | |
|---|----------------------|--|
|  | OMH-ML100-04 | Mounting aid for ML100 series, mounting bracket |
|  | OMH-ML100-05 | Mounting aid for ML100 series, mounting bracket |
|  | OMH-10 | Mounting aid for ML100 series |
|  | REF-C110-2 | Reflector, round ø 84 mm, central mounting hole |
|  | REF-H60-2 | Reflector with mounting holes |
|  | REF-H33 | Reflector with screw fixing |
|  | OFR-70-2 | Reflective tape 70 mm x 70 mm |
|  | OMH-ML100-08 | Mounting aid for ML100 series, Snap-in |
|  | REF-H85-2 | Reflector, rectangular 84.5 mm x 84.5 mm, mounting holes |
|  | REF-H50 | Reflector, rectangular 51 mm x 61 mm, mounting holes, fixing strap |
|  | OFR-100/100 | Reflective tape 100 mm x 100 mm |
|  | V31-GM-2M-PUR | Female cordset single-ended M8 straight A-coded, 4-pin, PUR cable grey |
|  | V31-WM-2M-PUR | Female cordset single-ended M8 angled A-coded, 4-pin, PUR cable grey |