



## Adapter cable

V1-180-W-BK1,5M-PUR-U-DT3P-G-Y

- Hard-wearing PUR cable
- Degree of protection IP68
- Resistant to microbes and hydrolysis
- UV resistant
- Oil resistant
- Halogen-free
- Knurled nut suitable for tool assembly
- Immunity to vibration, with mechanical latching
- Contact carrier rotated by 180°

Adapter cable M12 socket straight A-coded 4-pin to Deutsch plug straight 3-pin, PUR cable black, oil resistant



### Dimensions

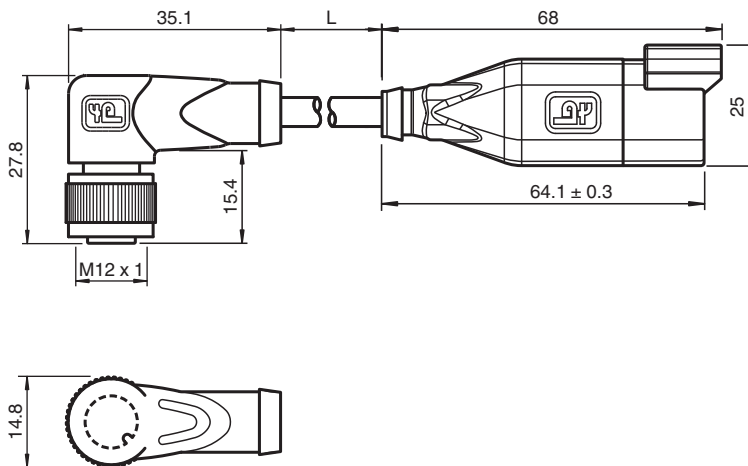

### Technical Data

#### General specifications

<b>Connector 1</b>	
Connection	socket
Construction type	M12
Style	angled
Locking	screw connection
Number of pins	4
Coding	A-coded
Customization	contact carrier rotated by 180°
<b>Connector 2</b>	
Connection	plug
Construction type	Deutsch connectors
Style	straight
Locking	snap locking
Number of pins	3

#### Electrical specifications

Release date: 2023-05-04 Date of issue: 2023-05-04 Filename: 70117963\_eng.pdf

Refer to "General Notes Relating to Pepperl+Fuchs Product Information".

Pepperl+Fuchs Group  
www.pepperl-fuchs.com

USA: +1 330 486 0001  
fa-info@us.pepperl-fuchs.com

Germany: +49 621 776 1111  
fa-info@de.pepperl-fuchs.com

Singapore: +65 6779 9091  
fa-info@sg.pepperl-fuchs.com

PEPPERL+FUCHS

## Technical Data

Operating voltage	U <sub>B</sub>	max. 48 V AC / 60 V DC to be defined
Operating current	I <sub>B</sub>	max. 4 A
<b>Conformity</b>		
Degree of protection		EN 60529
Plug connection		connector M12 x 1 : IEC 61076-2-101
Flammability		to be defined
Halogen-free		IEC 60754-1
Chemical resistance		DIN EN 60811-2-1
Microbial resistance		EN 50360
Hydrolysis resistance		EN 50360
Oil resistance		DIN EN 60811-2-1
<b>Ambient conditions</b>		
Ambient temperature		
Connector 1		-40 ... 90 °C (-40 ... 194 °F)
Connector 2		-40 ... 125 °C (-40 ... 257 °F)
Cable, fixed		-40 ... 80 °C (-40 ... 176 °F)
Cable, flexing		-20 ... 80 °C (-4 ... 176 °F)
Pollution degree		3
<b>Mechanical specifications</b>		
Connector 1		
Tightening torque		0.6 Nm
Loosening protection		available
Tool installation		straight knurling
Mating cycles		min. 100
Degree of protection		IP67 / IP68 / IP69
Connector 2		
Loosening protection		available
Degree of protection		IP68
Cable		
Sheath diameter		4.3 mm
Bending radius		> 15 x cable diameter, moving > 8 x cable diameter, fixed
Sheath stripping force		max. 50 N / 300 mm
Sheath color		black (similar to RAL 9005)
Number of cores		2
Core cross section		0.5 mm <sup>2</sup>
Cores color		Core 1-A: brown Core 3-C: blue
Core construction		16 x 0.2 mm Ø twisted pairs
Length	L	1.5 m
Cable code		Li 9Y 11YM 2 x 0,5
<b>Material</b>		
PWIS free		no
Halogen-free		yes
Connector 1		
Screw connection		Zinc diecast, nickel-plated
Body		TPU, black
Contact surface		Au
Flammability		V-2
Connector 2		
Body		PA, black
Contact surface		Ni
Flammability		V-0

Release date: 2023-05-04 Date of issue: 2023-05-04 Filename: 70117963\_eng.pdf

Refer to "General Notes Relating to Pepperl+Fuchs Product Information".

Pepperl+Fuchs Group  
www.pepperl-fuchs.comUSA: +1 330 486 0001  
fa-info@us.pepperl-fuchs.comGermany: +49 621 776 1111  
fa-info@de.pepperl-fuchs.comSingapore: +65 6779 9091  
fa-info@sg.pepperl-fuchs.com

**PEPPERL+FUCHS**





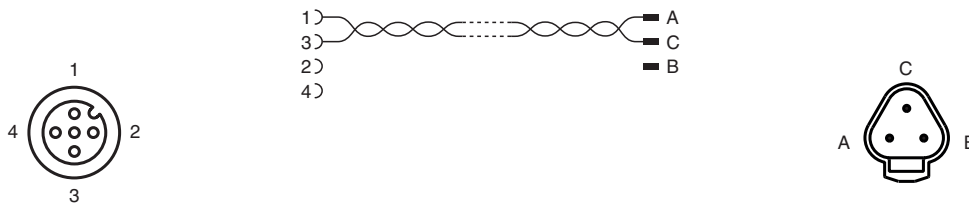

## Technical Data

Cable		
Sheathing		PUR based on polyether
Core insulation		PP
UV resistance		yes
Chemical resistance		good
Oil resistance		yes
Cooling lubricant resistance		yes
Microbial resistance		yes
Hydrolysis resistance		yes
Flammability		to be defined

## Connection



## Accessories

	<b>MH V1-SCREWDRIVER</b>	Torque screwdriver (0.6 Nm)
	<b>MH V1-BIT M12</b>	plug-in cap M12
	<b>V1/V3-LABELHOLDER</b>	Label holder
	<b>V1/V3-LABEL</b>	Label plate
	<b>MH V1-Holder</b>	Modular universal holder for M12 connectors
	<b>V1-CLIP</b>	Unlocking protector for M12 connector
	<b>V1-MARKING-RING-COLOR</b>	Marking rings for M12 connectors, various colors

Release date: 2023-05-04 Date of issue: 2023-05-04 Filename: 70117963\_eng.pdf