



Ultrasonic sensor

UC800-F77S-IU-IO-V31

- IO-Link interface for parameterization
- Programmable via DTM with PACTWARE
- Selectable sound lobe width
- Synchronization options
- Temperature compensation
- Analog output

Single head system



Dimensions

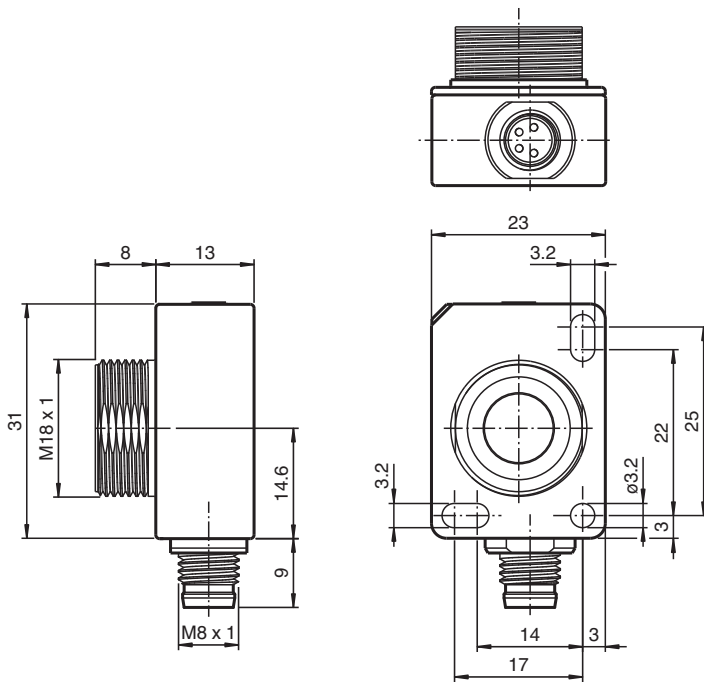

Technical Data

General specifications

Sensing range	60 ... 800 mm
Adjustment range	70 ... 800 mm
Dead band	0 ... 60 mm
Standard target plate	100 mm x 100 mm
Transducer frequency	approx. 255 kHz
Response delay	minimum : 13 ms factory setting: 49 ms
Sensor cycle time	≥ 13 ms (factory setting) ; programmable to 60 s

Memory

Release date: 2022-12-01 Date of issue: 2022-12-01 Filename: 261248_eng.pdf

Refer to "General Notes Relating to Pepperl+Fuchs Product Information".

Pepperl+Fuchs Group
www.pepperl-fuchs.com

USA: +1 330 486 0001
fa-info@us.pepperl-fuchs.com

Germany: +49 621 776 1111
fa-info@de.pepperl-fuchs.com

Singapore: +65 6779 9091
fa-info@sg.pepperl-fuchs.com

pf PEPPERL+FUCHS

Technical Data

Non-volatile memory	EEPROM	
Write cycles	300000	
Indicators/operating means		
LED green	solid: power on flashing: standby mode or IO-Link communication	
LED yellow	solid: object in evaluation range flashing: programming of the limits, object detected	
LED red	solid: fault flashing: programming limits, object not detected	
Electrical specifications		
Operating voltage	U_B	18 ... 30 V DC , ripple 10 % _{SS}
No-load supply current	I_0	≤ 50 mA
Power consumption	P_0	≤ 500 mW
Time delay before availability	t_v	≤ 300 ms
Interface		
Interface type	IO-Link (available after activation via programming button until next reset)	
Input/Output		
Input/output type	1 synchronization connection, bidirectional	
0 Level	0 ... 1 V	
1 Level	2.5 V ... U_B	
Input impedance	> 22 kΩ	
Output rated operating current	current source < 2.5 mA	
Pulse length	≥ 1 ms with external control, low active	
Synchronization frequency		
Common mode operation	≤ 82 Hz	
Multiplex operation	≤ 82 Hz / n , n = number of sensors , n ≤ 10	
Output		
Output type	1 analog output 0 (4) ... 20 mA or 1 analog output 0 ... 10 V	
Resolution	current output: evaluation range [mm]/3200 but ≥ 0.35 mm voltage output: evaluation range [mm]/4000 but ≥ 0.35 mm	
Deviation of the characteristic curve	≤ ± 1 % of full-scale value	
Repeat accuracy	≤ ± 0.1 % of full-scale value	
Load impedance	current output: ≤ 500 Ohm voltage output: ≥ 1000 Ohm	
Temperature influence	≤ ± 0.75 % of the end value (with temperature compensation) from 10 minutes after switching on the sensor ; 0.17 %/K (without temperature compensation)	
Compliance with standards and directives		
Standard conformity		
Standards	EN IEC 60947-5-2:2020 IEC 60947-5-2:2019 EN 60947-5-7:2003 IEC 60947-5-7:2003	
Approvals and certificates		
UL approval	cULus Listed, Class 2 Power Source	
CCC approval	CCC approval / marking not required for products rated ≤36 V	
Ambient conditions		
Ambient temperature	current output -25 ... 60 °C (-13 ... 140 °F) voltage output -25 ... 70 °C (-13 ... 158 °F) When fixing with one M18 nut, the temperature range for each begins with 0 °C (32 °F).	
Storage temperature	-40 ... 85 °C (-40 ... 185 °F)	
Mechanical specifications		
Connection type	Connector plug M8 x 1 , 4-pin	
Degree of protection	IP67	
Material		

Release date: 2022-12-01 Date of issue: 2022-12-01 Filename: 261248_eng.pdf

Refer to "General Notes Relating to Pepperl+Fuchs Product Information".

Pepperl+Fuchs Group
www.pepperl-fuchs.comUSA: +1 330 486 0001
fa-info@us.pepperl-fuchs.comGermany: +49 621 776 1111
fa-info@de.pepperl-fuchs.comSingapore: +65 6779 9091
fa-info@sg.pepperl-fuchs.com

PEPPERL+FUCHS

Technical Data

Housing	Polycarbonate
Transducer	epoxy resin/hollow glass sphere mixture; polyurethane foam
Installation position	any position
Mass	13 g
Tightening torque, fastening screws	with M3 nuts max. 0.2 Nm with M18 nuts max. 1 Nm
Factory settings	
Output	near limit: 70 mm far limit: 800 mm Output mode: rising ramp output type: 4 ... 20 mA
Beam width	wide

Connection

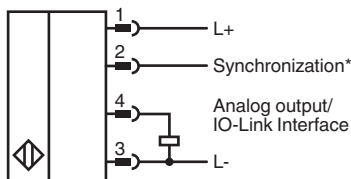

*if not used connect to ground (0V)

Connection Assignment



Wire colors in accordance with EN 60947-5-2

1	BN	(brown)
2	WH	(white)
3	BU	(blue)
4	BK	(black)

Characteristic Curve



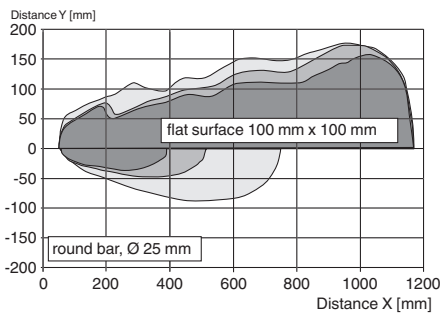



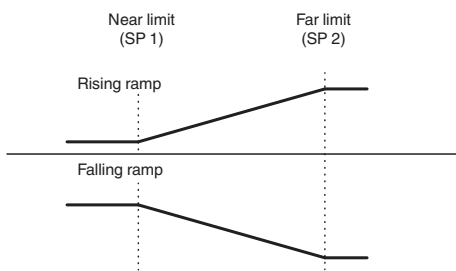

Characteristic response curve



Analog output modes







Accessories

	V31-GM-2M-PVC	Female cordset single-ended M8 straight A-coded, 4-pin, PVC cable grey
	V31-GM-1M-PVC-V1-G	Cordset M8 socket straight to M12 plug straight A-coded, 4-pin, PVC cable grey
	OMH-ML7-01	Mounting aid for ML7 and ML8 series, Mounting bracket
	OMH-ML7-02	Mounting aid for ML7 and ML8 series, Mounting bracket
	ICE2-8IOL-G65L-V1D	EtherNet/IP IO-Link master with 8 inputs/outputs
	ICE3-8IOL-G65L-V1D	PROFINET IO IO-Link master with 8 inputs/outputs
	ICE1-8IOL-G30L-V1D	Ethernet IO-Link module with 8 inputs/outputs
	ICE1-8IOL-G60L-V1D	Ethernet IO-Link module with 8 inputs/outputs
	ICE2-8IOL-K45P-RJ45	EtherNet/IP IO-Link master with 8 inputs/outputs, DIN rail, push-in connectors

Release date: 2022-12-01 Date of issue: 2022-12-01 Filename: 261248_eng.pdf

Refer to "General Notes Relating to Pepperl+Fuchs Product Information".

Accessories

	ICE2-8IOL-K45S-RJ45	EtherNet/IP IO-Link master with 8 inputs/outputs, DIN rail, screw terminal
	ICE3-8IOL-K45P-RJ45	PROFINET IO IO-Link master with 8 inputs/outputs, DIN rail, push-in terminals
	ICE3-8IOL-K45S-RJ45	PROFINET IO IO-Link master with 8 inputs/outputs, DIN rail, screw terminal
	IO-Link-Master02-USB	IO-Link master, supply via USB port or separate power supply, LED indicators, M12 plug for sensor connection

Release date: 2022-12-01 Date of issue: 2022-12-01 Filename: 261248_eng.pdf

Refer to "General Notes Relating to Pepperl+Fuchs Product Information".

Pepperl+Fuchs Group
www.pepperl-fuchs.com

USA: +1 330 486 0001
fa-info@us.pepperl-fuchs.com

Germany: +49 621 776 1111
fa-info@de.pepperl-fuchs.com

Singapore: +65 6779 9091
fa-info@sg.pepperl-fuchs.com

Function

Adjustment possibilities

The sensor features an analog output with 2 programmable limits. Programming the limits, the output mode, the output type and the beam width can be done in two different ways:

- Using the sensor's programming button
- Using the IO-link interface of the sensor. This method requires an IO-link master (e.g. IO-link-Master02-USB) and the associated software. The download link is available on the product page for the sensor at www.pepperl-fuchs.de

Synchronization

The sensor features a synchronization input for suppressing ultrasonic mutual interference („cross talk“).

The following synchronization modes are available:

1. Automatic multiplex mode.
2. Automatic common mode
3. Externally controlled synchronization

Further Documentation

- For information on programming via programming button and synchronisation you may refer to the commissioning instruction.
- For detailed information on application and programming via IO-Link we provide a manual.