

Mounting aid

OMH-K02

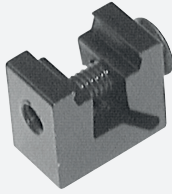

- Mounting clamp
- Simple and fast mounting

dove tail mounting clamp



Dimensions

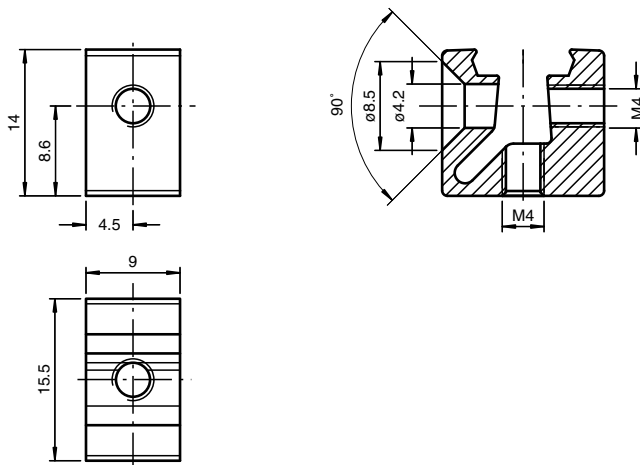

Technical Data

Mechanical specifications	
Material	anodized aluminum
Mass	approx. 5 g
Suitable series	
Series	MLV12
Safety Series	SL12, SLA12

Release date: 2020-03-21 Date of issue: 2020-06-29 Filename: 115636_eng.pdf

Refer to "General Notes Relating to Pepperl+Fuchs Product Information".

Pepperl+Fuchs Group
www.pepperl-fuchs.com

USA: +1 330 486 0001
fa-info@us.pepperl-fuchs.com

Germany: +49 621 776 1111
fa-info@de.pepperl-fuchs.com

Singapore: +65 6779 9091
fa-info@sg.pepperl-fuchs.com

PEPPERL+FUCHS