



Laser light sensor VLM350-F280-R4-1101

- Resolution 1280 x 960 pixel
- Comparison of up to 32 height profiles
- Output of X/Z offset
- Intelligent exposure time control
- Laser class 1, eyesafe
- Data Matrix control codes for parameterization

Laser light sensor for profile matching; Comparison of up to 32 height profiles; Output of X/Z offset; Resolution: 1280 x 960 pixel; Measuring range: X = 40 ... 160 mm, Z = 60 ... 350 mm; Scan rate: 30 s-1; 2 digital outputs; RS-485 interface



Function

The SmartRunner Matcher compares current height profiles with a previously taught-in height profile. The Matcher is based on innovative SmartRunner technology and combines the light section method for detecting height profiles with a 2-D vision sensor. The light section method involves projecting a laser line onto an object. This is then detected by a camera at a specific angle. A height profile is then created using the triangulation principle. This innovative laser technology provides reliable measurements on different surfaces.

Dimensions

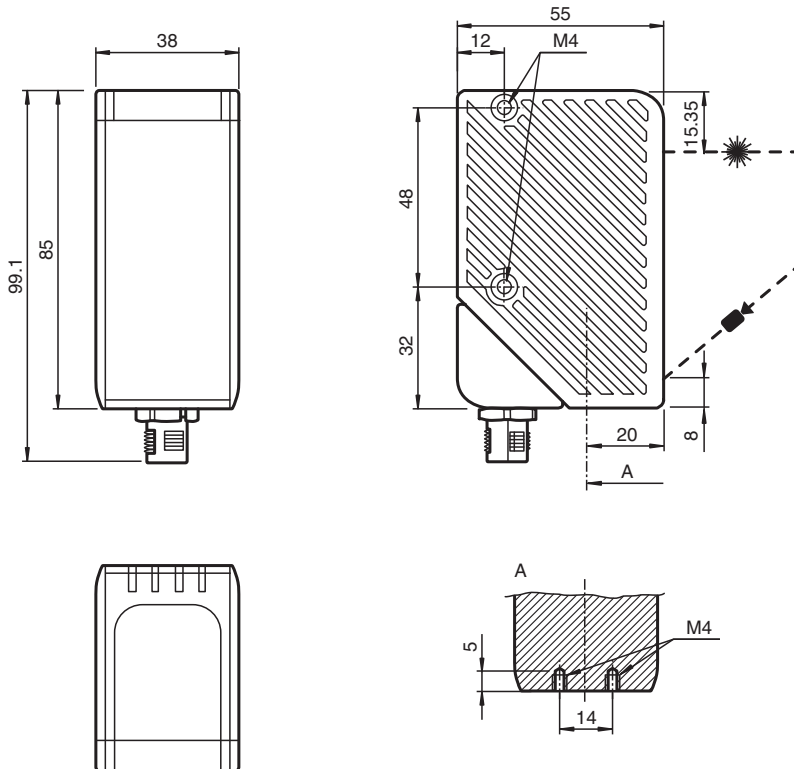

Release date: 2023-03-31 Date of issue: 2023-03-31 Filename: 284586-100004_eng.pdf

Refer to "General Notes Relating to Pepperl+Fuchs Product Information".

Pepperl+Fuchs Group
www.pepperl-fuchs.com

USA: +1 330 486 0001
fa-info@us.pepperl-fuchs.com

Germany: +49 621 776 1111
fa-info@de.pepperl-fuchs.com

Singapore: +65 6779 9091
fa-info@sg.pepperl-fuchs.com

PF PEPPERL+FUCHS

Technical Data

General specifications	
Measurement range	X = 40 ... 160 mm ; Z = 60 ... 350 mm
Light source	laser diode
Light type	red laser + Integrated LED lightning red 650 nm
Laser nominal ratings	
Note	VISIBLE LASER RADIATION , DO NOT STARE INTO BEAM DO NOT VIEW DIRECTLY WITH OPTICAL INSTRUMENTS
Laser class	1
Wave length	Measuring laser: 660 nm
Pulse length	Measuring laser: 0.5 ms
Maximum optical power output	Measuring laser: 15 mW
Laser monitoring	The safety system switches off the laser when the laser current is too high
Scan rate	30 s ⁻¹
Resolution	X>0.25 mm; Z>0.2 mm at 60 mm distance X>0.5 mm; Z>0.6 mm at 200 mm distance X>0.9 mm; Z>1.3 mm at 350 mm distance
Functional safety related parameters	
MTTF _d	20 a
Mission Time (T _M)	10 a
Diagnostic Coverage (DC)	0 %
Indicators/operating means	
Operation indicator	LED green
Diagnostics indicator	LED yellow / red
Function indicator	Trigger: LED yellow ; object detected : LED red / green
Control elements	2 push-buttons
Electrical specifications	
Operating voltage	U _B 24 V ± 20 % , PELV
No-load supply current	I ₀ max. 250 mA
Power consumption	P ₀ max. 6 W , Outputs without load
Interface	
Interface type	RS 485 interface
Physical	Switchable terminal resistor
Protocol	binary code
Transfer rate	38400 ... 230400 Bit/s
Input	
Input voltage	24 V
Number/Type	External triggering + 1 Input
Switching threshold	low: < 2.5 V, high: > 8 V
Output	
Number/Type	2 digital outputs
Switching type	PNP
Switching voltage	24 V
Switching current	150 mA each output
Compliance with standards and directives	
Standard conformity	
Noise immunity	EN 61000-6-2:2005
Emitted interference	EN 61000-6-4:2007/A1:2011
Degree of protection	EN 60529
Shock and impact resistance	EN 60068-2-27:2009
Laser class	IEC 60825-1:2007
Approvals and certificates	
UL approval	cULus Listed, Type 1 enclosure
CCC approval	CCC approval / marking not required for products rated ≤36 V

Release date: 2023-03-31 Date of issue: 2023-03-31 Filename: 284586-100004_eng.pdf

Technical Data

Approvals	CE
Ambient conditions	
Operating temperature	-20 ... 45 °C (-4 ... 113 °F) , (noncondensing; prevent icing on the lens!)
Storage temperature	-20 ... 70 °C (-4 ... 158 °F)
Mechanical specifications	
Housing width	38 mm
Housing height	85 mm
Housing depth	55 mm
Degree of protection	IP67
Connection	8-pin, M12 x 1 connector (supply + RS485 + Inputs/Outputs) ; can be rotated 90° ; Grounding : Grounding clip for PCV system
Material	
Housing	PC/ABS
Optical face	Plastic pane
Mass	approx. 125 g
Tightening torque, fastening screws	max. 2 Nm
General information	
Note	<p>Security Instructions:</p> <ul style="list-style-type: none"> - Read the operating instructions before attempting commissioning - Installation, connection and adjustments should only be undertaken by specialist personnel - Not a safety component in accordance with the EU Machinery Directive

Connection

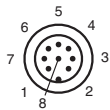

Pin	Signal
1	IN Trigger
2	+UB
3	Data+ RS-485
4	Data- RS-485
5	Teach
6	Good
7	GND
8	Bad

Assembly

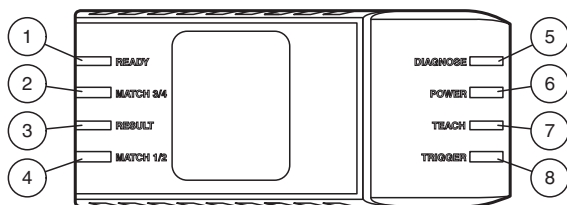











1	Ready	green/red
2	Match 3/4	green/yellow
3	Result	green/red
4	Match 1/2	green/yellow
5	Diagnose	red
6	Power	green
7	Teach	yellow
8	Trigger	yellow

Release date: 2023-03-31 Date of issue: 2023-03-31 Filename: 284586-100004_eng.pdf

Safety Information



Accessories

	V19-G-5M-PUR-ABG	Female cordset single-ended M12 straight A-coded, 8-pin, PUR cable grey, shielded
	VLX-MB2	Mounting bracket
	VLX-MB1	Mounting bracket
	PCV-USB- RS485-Converter Set	USB to RS 485 interface converter
	V19-G-BK0,6M-PUR-U- V1-G-SRMAT	Cordset for SmartRunner Matcher, M12 to M12, 8/4-pin, PUR cable
	VLX-F231-B6	Interface module with PROFIBUS interface for SmartRunner
	VLX-F231-B17	Interface module with PROFINET interface for SmartRunner
	VLX-F231-B21	Interface module with EtherCAT interface for SmartRunner
	VLX-F231-B25	Interface module with EtherNet/IP interface for SmartRunner
	VLX-F280-C	Weld slag cover model
	VLX-F280-C-GLASS	Replacement glass for SmartRunner protective housing

Release date: 2023-03-31 Date of issue: 2023-03-31 Filename: 284586-100004_eng.pdf

Refer to "General Notes Relating to Pepperl+Fuchs Product Information".

Pepperl+Fuchs Group
www.pepperl-fuchs.com

USA: +1 330 486 0001
fa-info@us.pepperl-fuchs.com

Germany: +49 621 776 1111
fa-info@de.pepperl-fuchs.com

Singapore: +65 6779 9091
fa-info@sg.pepperl-fuchs.com

 **PEPPERL+FUCHS**

Installation Conditions

Measuring range

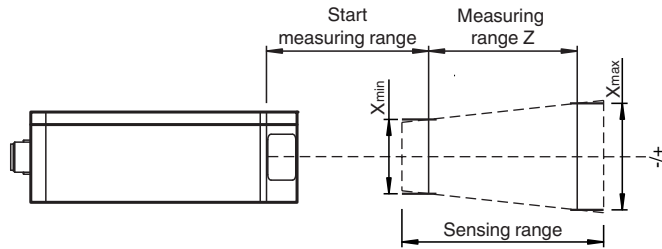

Safety Information



**LASERLICHT
LASER LIGHT**

**LASER KLASSE 1
CLASS 1 LASER PRODUCT**

Safety Information

Laser Class 1 Information

The irradiation can lead to irritation especially in a dark environment. Do not point at people!

Maintenance and repairs should only be carried out by authorized service personnel!

Attach the device so that the warning is clearly visible and readable.

The warning accompanies the device and should be attached in immediate proximity to the device.

Caution – Use of controls or adjustments or performance of procedures other than those specified herein may result in hazardous radiation exposure.

Release date: 2023-03-31 Date of issue: 2023-03-31 Filename: 284586-100004_eng.pdf