



Triangulation sensor (BGS)

OBT40-R102-2P1-IO-0,3M-V1



- Miniature design with versatile mounting options
- Best background suppressor in its class
- Precision object detection, almost irrespective of the color
- Extended temperature range
-40 °C ... 60 °C
- High degree of protection IP69K
- IO-Link interface for service and process data

Triangulation sensor with background suppression



Function

The miniature optical sensors are the first devices of their kind to offer an end-to-end solution in a small single standard design — from thru-beam sensor through to a distance measurement device. As a result of this design, the sensors are able to perform practically all standard automation tasks.

The DuraBeam laser sensors are durable and can be used in the same way as a standard sensor.

The use of Multi Pixel Technology gives the standard sensors a high level of flexibility and enables them to adapt more effectively to their operating environment.

Dimensions

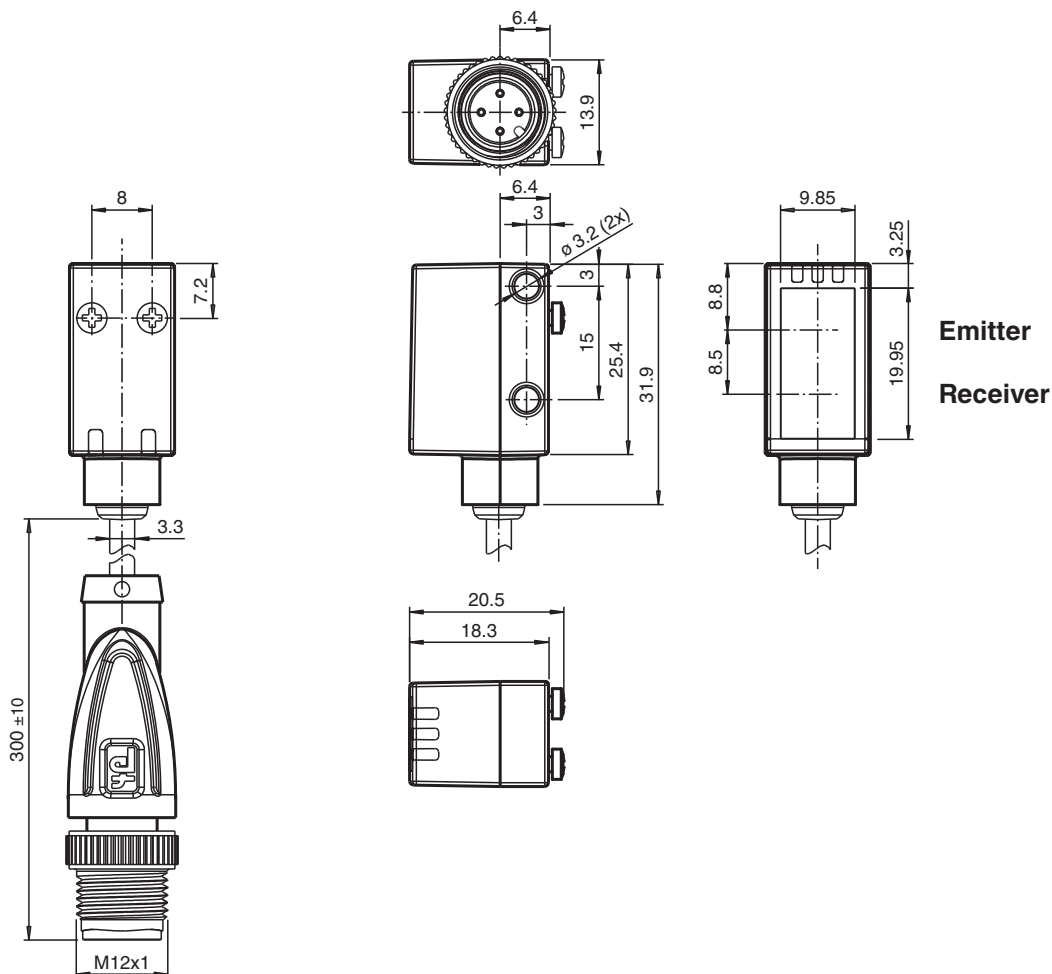

Release date: 2023-04-05 Date of issue: 2023-04-05 Filename: 267075-100550_eng.pdf

Refer to "General Notes Relating to Pepperl+Fuchs Product Information".

Pepperl+Fuchs Group
www.pepperl-fuchs.com

USA: +1 330 486 0001
fa-info@us.pepperl-fuchs.com

Germany: +49 621 776 1111
fa-info@de.pepperl-fuchs.com

Singapore: +65 6779 9091
fa-info@sg.pepperl-fuchs.com

PF PEPPERL+FUCHS

Technical Data

General specifications		
Detection range		10 ... 40 mm
Detection range max.		10 ... 50 mm
Background suppression		starts from 50 mm
Reference target		standard white, 100 mm x 100 mm
Light source		LED
Light type		modulated visible red light
LED risk group labelling		exempt group
Black-white difference (6 %/90 %)		approx. 1 mm
Diameter of the light spot		approx. 3 mm at 40 mm
Opening angle		approx. 5 °
Ambient light limit		EN 60947-5-2 : 40000 Lux
Functional safety related parameters		
MTTF _d		600 a
Mission Time (T _M)		20 a
Diagnostic Coverage (DC)		0 %
Indicators/operating means		
Operation indicator		LED green: constantly on - power on flashing (4Hz) - short circuit flashing with short break (1 Hz) - IO-Link mode
Function indicator		LED yellow: constantly on - object detected constantly off - object not detected
Electrical specifications		
Operating voltage	U _B	10 ... 30 V DC
Ripple		max. 10 %
No-load supply current	I ₀	< 25 mA at 24 V supply voltage
Protection class		III
Interface		
Interface type		IO-Link (via C/Q = BK)
IO-Link revision		1.1
Device profile		Smart Sensor
Device ID		0x110513 (1115411)
Transfer rate		COM2 (38.4 kBit/s)
Min. cycle time		2.3 ms
Process data width		Process data input 1 Bit Process data output 2 Bit
SIO mode support		yes
Compatible master port type		A
Output		
Switching type		C/Q - Pin4: NPN normally closed / dark-on, PNP normally open / light-on, IO-Link /Q - Pin2: NPN normally open / light-on, PNP normally closed / dark-on
Signal output		2 push-pull (4 in 1) outputs, short-circuit protected, reverse polarity protected, overvoltage protected
Switching voltage		max. 30 V DC
Switching current		max. 100 mA , resistive load
Usage category		DC-12 and DC-13
Voltage drop	U _d	≤ 1.5 V DC
Switching frequency	f	500 Hz
Response time		1 ms
Conformity		
Communication interface		IEC 61131-9
Product standard		EN 60947-5-2
Approvals and certificates		

Release date: 2023-04-05 Date of issue: 2023-04-05 Filename: 267075-100550_eng.pdf

Refer to "General Notes Relating to Pepperl+Fuchs Product Information".

 Pepperl+Fuchs Group
www.pepperl-fuchs.com

 USA: +1 330 486 0001
fa-info@us.pepperl-fuchs.com

 Germany: +49 621 776 1111
fa-info@de.pepperl-fuchs.com

 Singapore: +65 6779 9091
fa-info@sg.pepperl-fuchs.com

 **PEPPERL+FUCHS**

Technical Data

UL approval	E87056 , cULus Listed , class 2 power supply , type rating 1
Ambient conditions	
Ambient temperature	-40 ... 60 °C (-40 ... 140 °F) , fixed cable -25 ... 60 °C (-13 ... 140 °F) , movable cable not appropriate for conveyor chains
Storage temperature	-40 ... 70 °C (-40 ... 158 °F)
Mechanical specifications	
Housing width	13.9 mm
Housing height	31.9 mm
Housing depth	18.3 mm
Degree of protection	IP67 / IP69 / IP69K
Connection	300 mm fixed cable with M12 x 1, 4-pin connector
Material	
Housing	PC (Polycarbonate)
Optical face	Float glass
Mass	approx. 17 g
Cable length	0.3 m

Connection

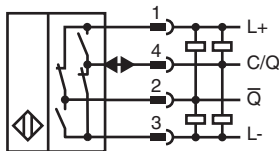

Connection Assignment

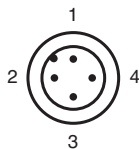

Wire colors in accordance with EN 60947-5-2

- | | | |
|---|----|---------|
| 1 | BN | (brown) |
| 2 | WH | (white) |
| 3 | BU | (blue) |
| 4 | BK | (black) |

Assembly

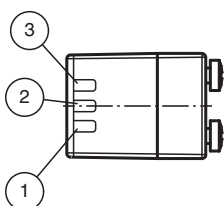

1	Operating indicator / dark on
2	Signal indicator
3	Operating indicator / light on

Release date: 2023-04-05 Date of issue: 2023-04-05 Filename: 267075-100550_eng.pdf

Characteristic Curve

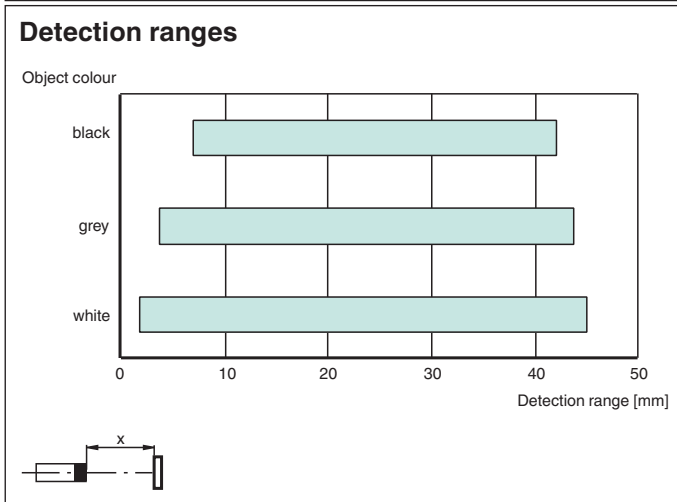
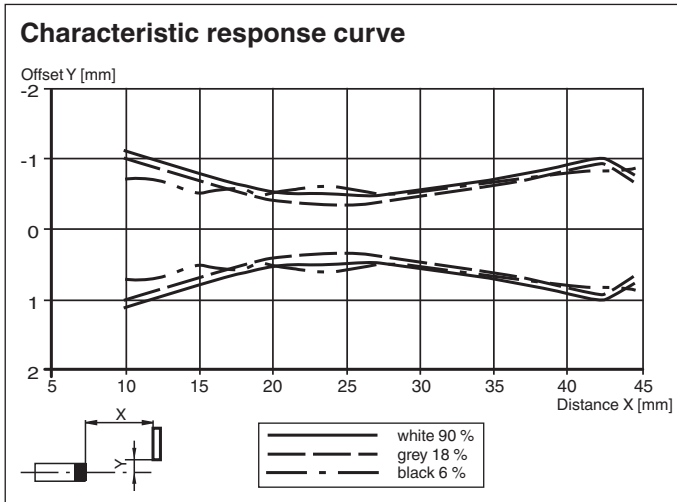



Accessories

	ICE2-8IOL-G65L-V1D	EtherNet/IP IO-Link master with 8 inputs/outputs
	ICE3-8IOL-G65L-V1D	PROFINET IO IO-Link master with 8 inputs/outputs
	ICE1-8IOL-G30L-V1D	Ethernet IO-Link module with 8 inputs/outputs
	ICE1-8IOL-G60L-V1D	Ethernet IO-Link module with 8 inputs/outputs
	ICE2-8IOL-K45P-RJ45	EtherNet/IP IO-Link master with 8 inputs/outputs, DIN rail, push-in connectors
	ICE2-8IOL-K45S-RJ45	EtherNet/IP IO-Link master with 8 inputs/outputs, DIN rail, screw terminal
	ICE3-8IOL-K45P-RJ45	PROFINET IO IO-Link master with 8 inputs/outputs, DIN rail, push-in terminals
	ICE3-8IOL-K45S-RJ45	PROFINET IO IO-Link master with 8 inputs/outputs, DIN rail, screw terminal

Release date: 2023-04-05 Date of issue: 2023-04-05 Filename: 267075-100550_eng.pdf

Accessories

	<p>IO-Link-Master02-USB</p>	<p>IO-Link master, supply via USB port or separate power supply, LED indicators, M12 plug for sensor connection</p>
	<p>V1-G-2M-PUR</p>	<p>Female cordset single-ended M12 straight A-coded, 4-pin, PUR cable grey</p>
	<p>V1-W-2M-PUR</p>	<p>Female cordset single-ended M12 angled A-coded, 4-pin, PUR cable grey</p>

Release date: 2023-04-05 Date of issue: 2023-04-05 Filename: 267075-100550_eng.pdf

Refer to "General Notes Relating to Pepperl+Fuchs Product Information".

Pepperl+Fuchs Group
www.pepperl-fuchs.com

USA: +1 330 486 0001
fa-info@us.pepperl-fuchs.com

Germany: +49 621 776 1111
fa-info@de.pepperl-fuchs.com

Singapore: +65 6779 9091
fa-info@sg.pepperl-fuchs.com