

Retroreflective sensor

GLV18-6/25/102/159

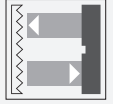

- Efficient Line in a short M18 plastic housing for standard applications
- Very high detection range
- 4 LEDs indicator for 360° visibility
- Optimized potentiometer design for a clear control button layout in the application
- Version with front optical face
- DC voltage version

Retroreflective sensor, M18 threaded housing design, plastic housing, front optical face, 6.5 m detection range, red light, light on, DC version, NPN output, M12 plug



Function

The GLV/GLK18 series sensors help improve the efficiency of machines and systems. The design of the M18 plastic housing, the connection technology, and sensor properties are highly standardized. Concentrating on the key sensor requirements has produced a robust and reliable product series for DC and AC/DC voltage systems without any over-engineering. The mounting set included in the scope of delivery and the optimized potentiometer design ensure fast assembly and easy configuration.

Application

Packaging industry:

- Presence checks, track loading, completeness checks, stack height control

Material handling:

- Presence checks, target sensor, profile checks, trigger sensor

Automatic doors, gates and access systems, elevator:

- Secure detection for automatic door and gate systems
- Monitoring function in turnstiles
- Closing edge monitoring in elevators

Dimensions

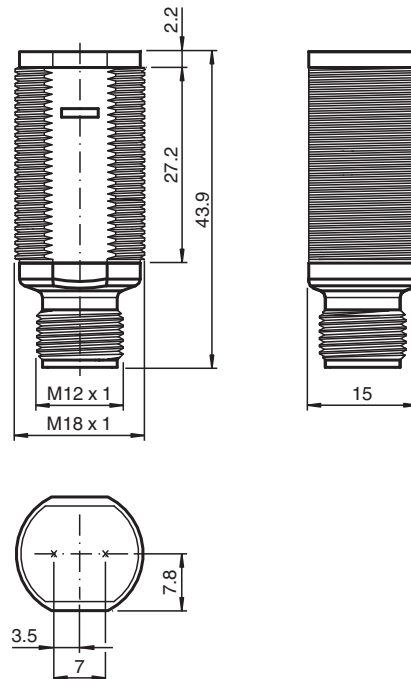

Technical Data

General specifications	
Effective detection range	0 ... 6.5 m
Reflector distance	0.05 ... 6.5 m
Threshold detection range	8 m
Reference target	reflector C110-2
Light source	LED
Light type	modulated visible red light , 640 nm
Polarization filter	no
Diameter of the light spot	approx. 300 mm at 8 m
Opening angle	approx. 2 °
Optical face	frontal
Ambient light limit	30000 Lux
Functional safety related parameters	
MTTF _d	920 a
Mission Time (T _M)	20 a
Diagnostic Coverage (DC)	0 %
Indicators/operating means	
Operation indicator	LED green, statically lit Power on
Function indicator	LED yellow: lights up when receiving the light beam ; flashes when falling short of the operating reserve; OFF when light beam is interrupted
Electrical specifications	
Operating voltage	U _B 10 ... 30 V DC
No-load supply current	I ₀ < 20 mA
Output	

Release date: 2023-03-28 Date of issue: 2023-03-28 Filename: 188552_eng.pdf

Technical Data

Switching type	light-on	
Signal output		1 NPN, short-circuit protected open collector
Switching voltage	max. 30 V DC	
Switching current	max. 100 mA	
Voltage drop	U_d	≤ 1.5 V DC
Switching frequency	f	500 Hz
Response time	≤ 1 ms	
Conformity		
Product standard	EN 60947-5-2	
Approvals and certificates		
Protection class	II, Rated insulation voltage ≤ 50 V AC with pollution degree 1-2 according to IEC 60664-1	
UL approval	cULus Listed, Class 2 Power Source	
CCC approval	CCC approval / marking not required for products rated ≤ 36 V	
Ambient conditions		
Ambient temperature	-25 ... 60 °C (-13 ... 140 °F)	
Storage temperature	-40 ... 70 °C (-40 ... 158 °F)	
Mechanical specifications		
Degree of protection	IP67	
Connection	3-pin, M12 x 1 connector	
Material		
Housing	PC	
Optical face	PMMA	
Connector	plastic	
Mass	approx. 10 g	

Connection Assignment

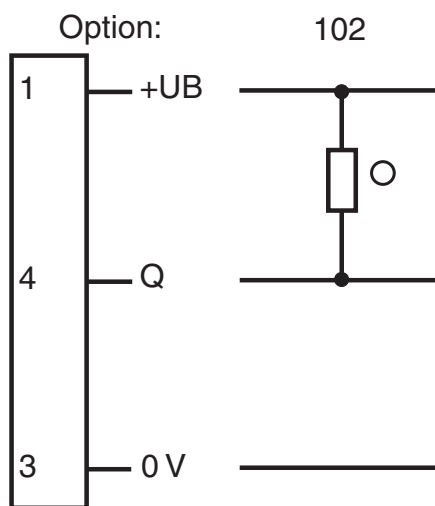

○ = Light on
● = Dark on

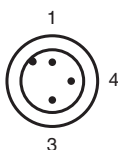

Release date: 2023-03-28 Date of issue: 2023-03-28 Filename: 188552_eng.pdf

Wire colors in accordance with EN 60947-5-2

- 1 | BN (brown)
- 3 | BU (blue)
- 4 | BK (black)

Assembly

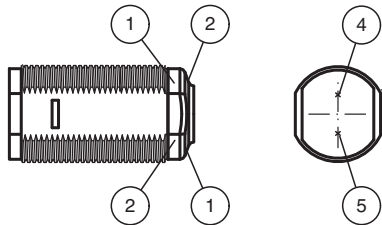



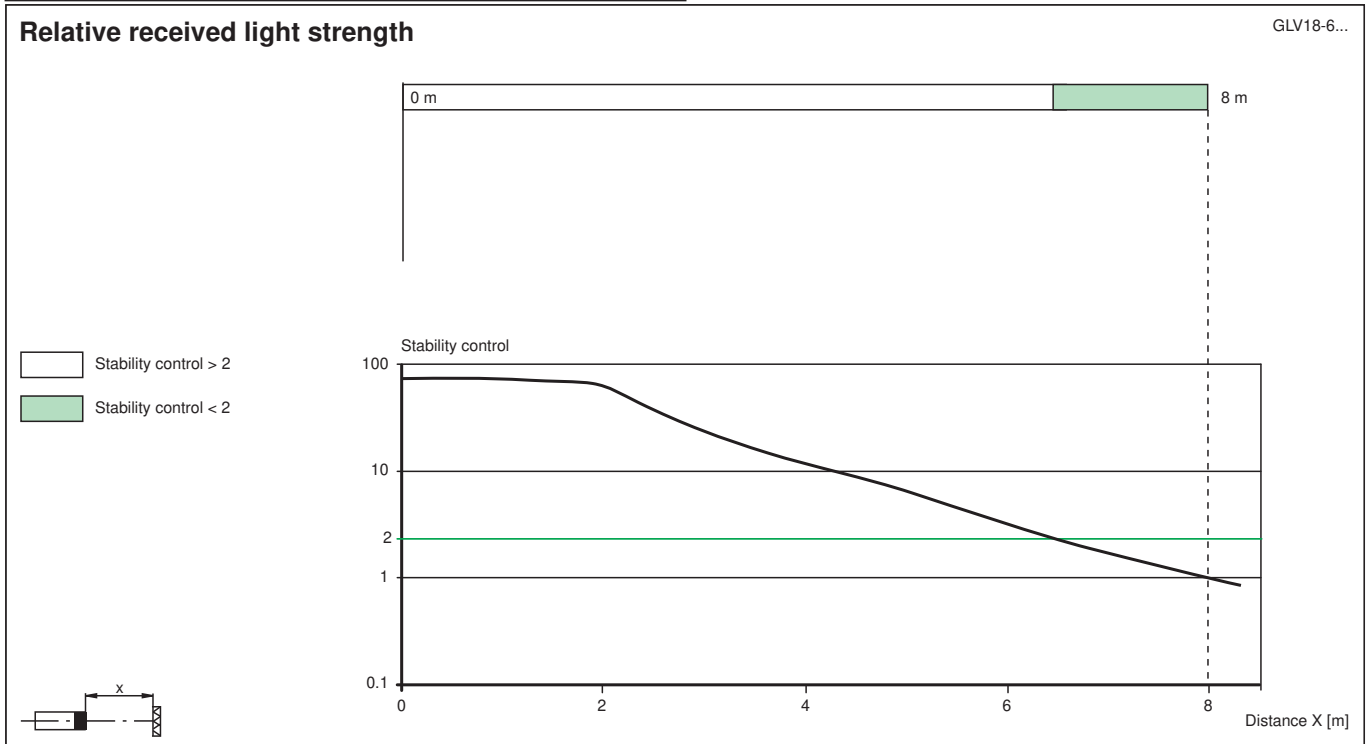
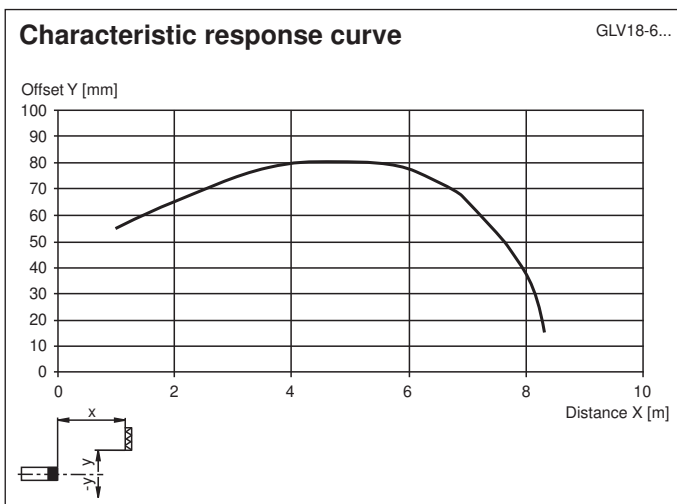

1	Operating display	green
2	Signal display	yellow
4	Emitter	
5	Receiver	

Characteristic Curve



Release date: 2023-03-28 Date of issue: 2023-03-28 Filename: 186552_eng.pdf

Accessories

	CPZ18B03	Mounting Bracket with swivel nut
	BF 18	Mounting flange, 18 mm
	BF 18-F	Plastic mounting adapter, 18 mm
	BF 5-30	Universal mounting bracket for cylindrical sensors with a diameter of 5 ... 30 mm
	V11-G-2M-PUR	Female cordset single-ended M12 straight A-coded, 3-pin, PUR cable grey