

Inductive positioning system

PMI80-F90-IU-IO-V15

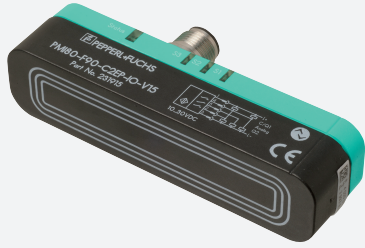

- Parameterization and diagnosis via IO-Link
- Measuring range 0 ... 80 mm
- Parameterisable measuring range
- Analog current or voltage output, programmable



Dimensions

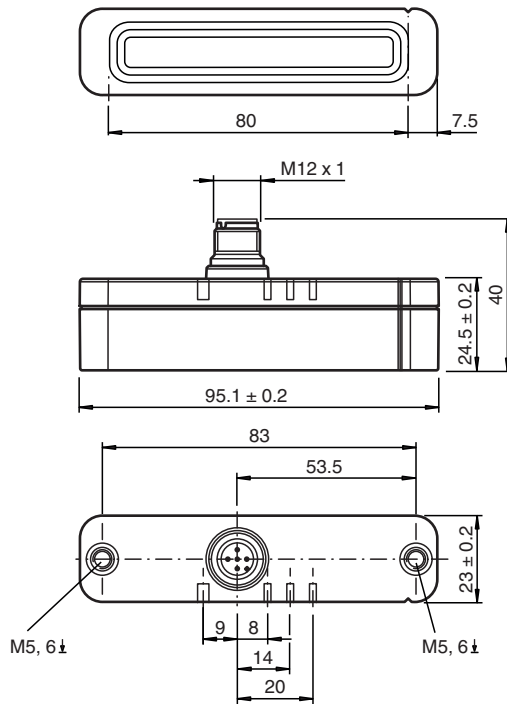

Technical Data

General specifications

Switching element function	Analog current or voltage output, programmable
Object distance	0.5 ... 3 mm , recommended: 1.5 mm
Measurement range	0 ... 80 mm
Linearity range	1 ... 79 mm

Nominal ratings

Operating voltage	U_B	12 ... 30 V DC (13 ... 30 V when analog voltage output is parameterized)
Reverse polarity protection		reverse polarity protected
Linearity error		within measuring range: ± 0.8 mm within linearity range: ± 0.4 mm

Release date: 2022-05-17 Date of issue: 2022-05-17 Filename: 315192_eng.pdf

Refer to "General Notes Relating to Pepperl+Fuchs Product Information".

Pepperl+Fuchs Group
www.pepperl-fuchs.com

USA: +1 330 486 0001
fa-info@us.pepperl-fuchs.com

Germany: +49 621 776 1111
fa-info@de.pepperl-fuchs.com

Singapore: +65 6779 9091
fa-info@sg.pepperl-fuchs.com

PF PEPPERL+FUCHS

Technical Data

Repeat accuracy	R	± 0.1 mm
Resolution		50 µm
Temperature drift		± 0.5 mm (-25 °C ... 70 °C)
No-load supply current	I ₀	≤ 40 mA
Operating voltage indicator		LED green
Functional safety related parameters		
MTTF _d		311 a
Mission Time (T _M)		20 a
Diagnostic Coverage (DC)		0 %
Indicators/operating means		
LED S3		Damping element in the configured analog measuring range
LED STATUS		Status display LED, green/red (Power on, communication/error, missing damping element)
Interface		
Interface type		IO-Link (via C/Q = Pin 4)
IO-Link revision		1.1
Device profile		Smart Sensor
Device ID		0x200301 (2097921)
Transfer rate		COM2 (38.4 kBaud)
Value range		0000h ... 6400h
Min. cycle time		2.3 ms
Process data width		Process data input: 16 Bit Process data output: none
SIO mode support		yes
Compatible master port type		A
Analog output		
Output type		current output 4-20 mA voltage output 0 - 5 V DC 0 ... 10 V DC , programmable
Load resistor		current output: ≤ 400 Ω voltage output: ≥ 1000 Ω
Short-circuit protection		voltage output: current limit
Compliance with standards and directives		
Standard conformity		
Standards		EN 60947-5-2:2007 EN 60947-5-2/A1:2012 IEC 60947-5-2:2007 IEC 60947-5-2 AMD 1:2012 EN 60947-5-7:2003 EN61131-9:2013 IEC 60947-5-7:2003 IEC 61131-9:2013
Approvals and certificates		
UL approval		cULus Listed, Class 2 Power Source, Type 1 enclosure
Marine approval		DNVGL TAA00001V2
Ambient conditions		
Ambient temperature		-25 ... 85 °C (-13 ... 185 °F)
Mechanical specifications		
Connection type		5-pin, M12 x 1 connector
Degree of protection		IP67 / IP69K
Material		
Housing		PBT, stainless steel 1.4571 , brass, nickel-plated
Target		mild steel, e. g. 1.0037, SR235JR (formerly St37-2)
Mass		83 g

Release date: 2022-05-17 Date of issue: 2022-05-17 Filename: 315192_eng.pdf

Refer to "General Notes Relating to Pepperl+Fuchs Product Information".

Pepperl+Fuchs Group
www.pepperl-fuchs.comUSA: +1 330 486 0001
fa-info@us.pepperl-fuchs.comGermany: +49 621 776 1111
fa-info@de.pepperl-fuchs.comSingapore: +65 6779 9091
fa-info@sg.pepperl-fuchs.com

PEPPERL+FUCHS

Connection

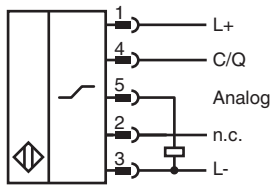

Connection Assignment



Wire colors in accordance with EN 60947-5-2

1	BN	(brown)
2	WH	(white)
3	BU	(blue)
4	BK	(black)
5	GY	(gray)

Application

dimensions for the target object:

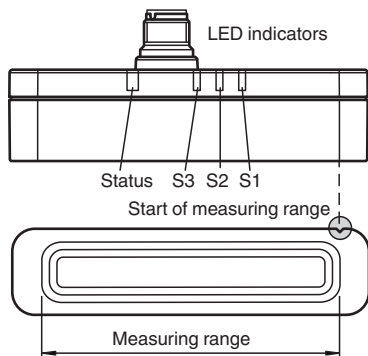
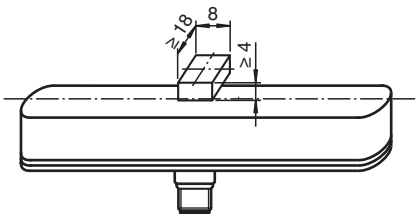









Release date: 2022-05-17 Date of issue: 2022-05-17 Filename: 315192_eng.pdf

Accessories

	BT-F90-W	Damping element for sensors of type F90, F112, and F166; side hole
--	-----------------	--

Accessories

	MH-F90	Mounting bracket for mounting of F90 sensors
	V15-G-2M-PVC	Female cordset single-ended M12 straight A-coded, 5-pin, PVC cable grey
	V15-W-2M-PVC	Female cordset single-ended M12 angled A-coded, 5-pin, PVC cable grey
	ICE2-8IOL-K45S-RJ45	EtherNet/IP IO-Link master with 8 inputs/outputs, DIN rail, screw terminal
	ICE3-8IOL-K45P-RJ45	PROFINET IO IO-Link master with 8 inputs/outputs, DIN rail, push-in terminals
	ICE3-8IOL-K45S-RJ45	PROFINET IO IO-Link master with 8 inputs/outputs, DIN rail, screw terminal
	IO-Link-Master02-USB	IO-Link master, supply via USB port or separate power supply, LED indicators, M12 plug for sensor connection
	ICE2-8IOL-K45P-RJ45	EtherNet/IP IO-Link master with 8 inputs/outputs, DIN rail, push-in connectors

Operation

Attention!

If the sensor is supplied via an IO-Link-Master, ensure that the sum of the no-load supply current and operating currents of all sensor outputs does not exceed the maximum current the IO-Link-Master can supply.