

Thru-beam sensor (pair)

OBE500-R2F-SE0-L



- Very flat design for direct mounting without mounting bracket
- DuraBeam Laser Sensors - durable and employable like an LED
- TEACH-IN
- Detection of partially transparent objects by teach-in
- Detection of small parts or flat objects from 0.25 mm

Thru-beam sensor, flat design, space-saving M2 mounting, 500 mm detection range, red light, dark on, NPN output, fixed cable



Dimensions

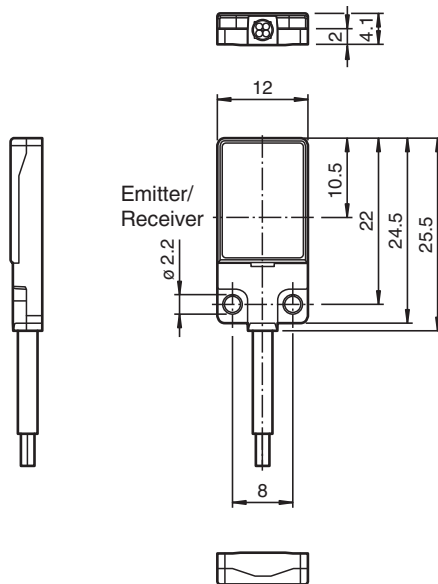

Technical Data

| System components | |
|---------------------------|--------------------------------------|
| Emitter | OBE500-R2F-S-L |
| Receiver | OBE500-R2F-E0-L |
| General specifications | |
| Effective detection range | 0 ... 500 mm |
| Threshold detection range | 700 mm |
| Light source | LASER LIGHT |
| Light type | modulated visible red light , 680 nm |

Release date: 2023-04-05 Date of issue: 2023-04-05 Filename: 280472_eng.pdf

Refer to "General Notes Relating to Pepperl+Fuchs Product Information".

Pepperl+Fuchs Group
www.pepperl-fuchs.com

USA: +1 330 486 0001
fa-info@us.pepperl-fuchs.com

Germany: +49 621 776 1111
fa-info@de.pepperl-fuchs.com

Singapore: +65 6779 9091
fa-info@sg.pepperl-fuchs.com

PF PEPPERL+FUCHS

Technical Data

| | | |
|---|---|--|
| Laser nominal ratings | | |
| Note | LASER LIGHT , DO NOT STARE INTO BEAM | |
| Laser class | 1 | |
| Wave length | 680 nm | |
| Beam divergence | > 5 mrad | |
| Pulse length | approx. 3 μ s | |
| Repetition rate | approx. 16.6 kHz | |
| max. pulse energy | 8 nJ | |
| Angle deviation | approx. 0.5 ° | |
| Object size | typ. starts from 0.5 mm ; typ. from 0.25 mm (after teach-in) | |
| Diameter of the light spot | approx. 4 mm at a distance of 500 mm | |
| Opening angle | approx. 1 ° | |
| Optical face | frontal | |
| Ambient light limit | EN 60947-5-2 : 25000 Lux | |
| Functional safety related parameters | | |
| MTTF _d | 806 a | |
| Mission Time (T _M) | 20 a | |
| Diagnostic Coverage (DC) | 0 % | |
| Indicators/operating means | | |
| Operation indicator | LED green, statically lit Power on , short-circuit : LED green flashing (approx. 4 Hz) | |
| Function indicator | Receiver: LED yellow, lights up when light beam is free, flashes when falling short of the operating reserve ; OFF when light beam is interrupted | |
| Electrical specifications | | |
| Operating voltage | U _B | 12 ... 24 V |
| No-load supply current | I ₀ | Emitter: \leq 10 mA Receiver: \leq 8 mA |
| Protection class | III | |
| Input | | |
| Test input | Test of switching function at 0 V | |
| Switching threshold | Teach-In input | |
| Output | | |
| Switching type | NO contact / dark-on | |
| Signal output | 1 NPN output, short-circuit protected, reverse polarity protected, open collector | |
| Switching voltage | max. 30 V DC | |
| Switching current | max. 50 mA , resistive load | |
| Voltage drop | U _d | \leq 1.5 V DC |
| Switching frequency | f | approx. 2 kHz |
| Response time | 250 μ s | |
| Conformity | | |
| Product standard | EN 60947-5-2 | |
| Laser safety | EN 60825-1:2007 | |
| Approvals and certificates | | |
| UL approval | E87056 , cULus Recognized, Class 2 Power Source | |
| CCC approval | CCC approval / marking not required for products rated \leq 36 V | |
| FDA approval | IEC 60825-1:2007 Complies with 21 CFR 1040.10 and 1040.11 except for deviations pursuant to Laser Notice No. 50, dated June 24, 2007 | |
| Ambient conditions | | |
| Ambient temperature | -10 ... 60 °C (14 ... 140 °F) | |
| Storage temperature | -20 ... 70 °C (-4 ... 158 °F) | |
| Mechanical specifications | | |
| Housing width | 12 mm | |
| Housing height | 25.5 mm | |
| Housing depth | 4.1 mm | |
| Degree of protection | IP67 | |

Release date: 2023-04-05 Date of issue: 2023-04-05 Filename: 280472_eng.pdf

Refer to "General Notes Relating to Pepperl+Fuchs Product Information".

Pepperl+Fuchs Group
www.pepperl-fuchs.comUSA: +1 330 486 0001
fa-info@us.pepperl-fuchs.comGermany: +49 621 776 1111
fa-info@de.pepperl-fuchs.comSingapore: +65 6779 9091
fa-info@sg.pepperl-fuchs.com

PEPPERL+FUCHS

Technical Data

| | |
|-------------------------------------|--|
| Connection | 2 m fixed cable |
| Material | |
| Housing | PC (Polycarbonate) and Stainless steel |
| Optical face | PMMA |
| Cable | PUR |
| Mass | approx. 20 g per sensor |
| Tightening torque, fastening screws | 0.25 Nm |
| Cable length | 2 m |

Connection

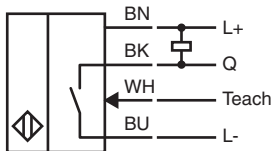
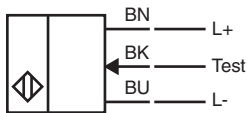

Characteristic Curve

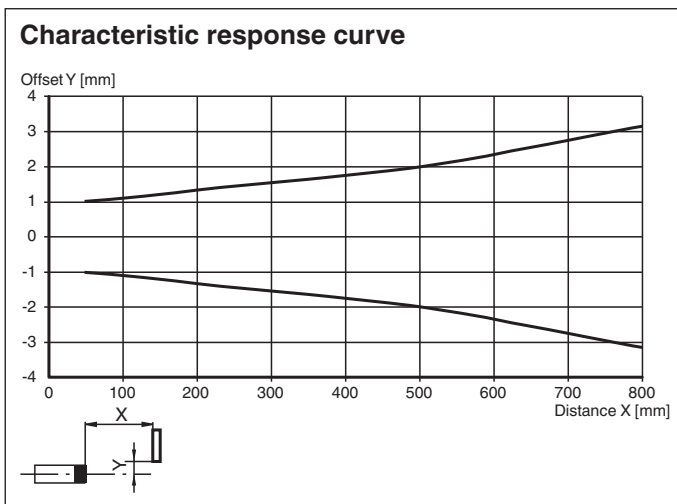

Release date: 2023-04-05 Date of issue: 2023-04-05 Filename: 280472_eng.pdf

Characteristic Curve

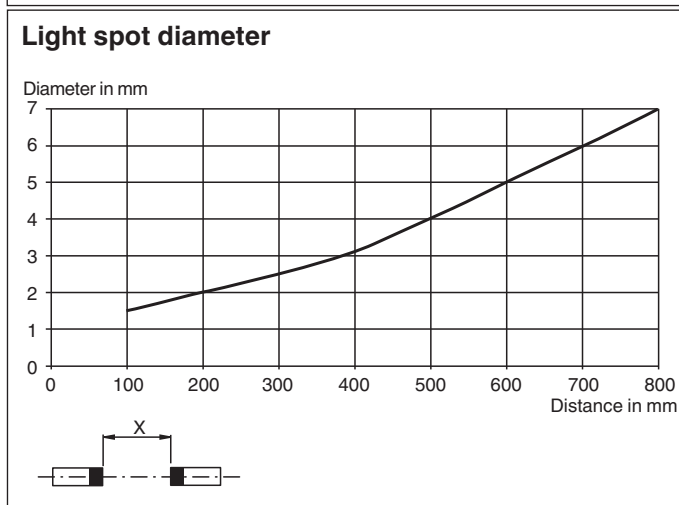
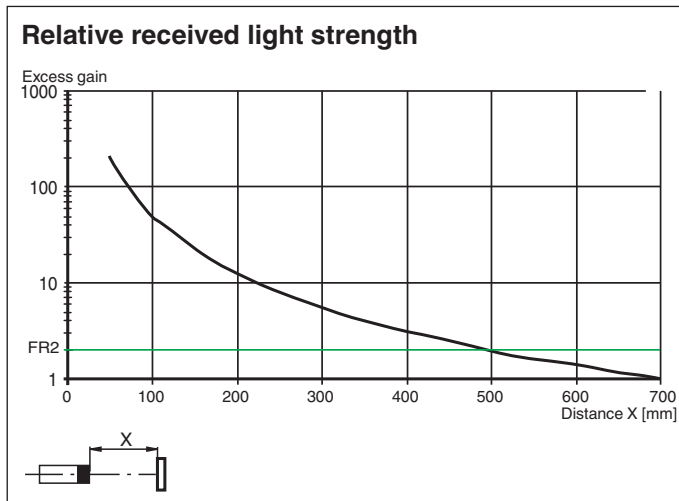

Safety Information

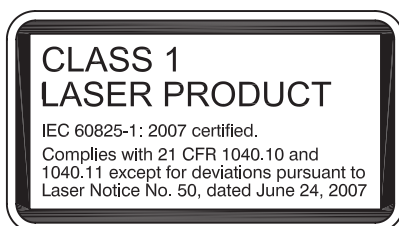

Release date: 2023-04-05 Date of issue: 2023-04-05 Filename: 280472_eng.pdf

Safety Information

Laser Class 1 Information

The irradiation can lead to irritation especially in a dark environment. Do not point at people!

Maintenance and repairs should only be carried out by authorized service personnel!

Attach the device so that the warning is clearly visible and readable.

The warning accompanies the device and should be attached in immediate proximity to the device.

Caution – Use of controls or adjustments or performance of procedures other than those specified herein may result in hazardous radiation exposure.

Teach-In

The thru-beam sensor enables the switching points to be taught in for optimum adaptation to specific applications. This eliminates the need for additional components such as apertures.

The sensitivity of the thru-beam sensor can be adjusted using three Teach-in methods:

Position Teach

When using this Teach-in method, the following settings are made on the thru-beam sensor:

- The gain is set to an optimum value
- The signal threshold is set to a minimum

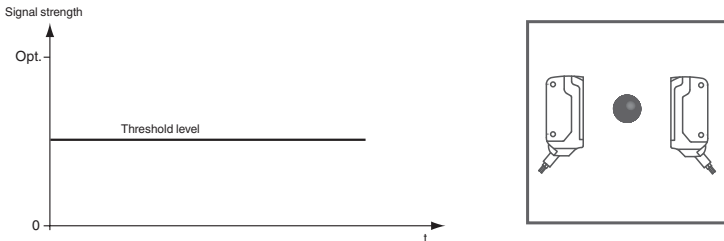

Recommended application:

This method enables minuscule particles in the beam path to be detected, and provides exceptional positioning accuracy. Make sure that there are no objects in the beam path and that the sensor is connected to the power supply.

1. Connect the white cable on the receiver (WH/IN) to the blue cable (BU/0 V) on the receiver. The green and yellow LED indicators flash simultaneously at 2.5 Hz
2. Disconnect the white cable on the receiver (WH/IN) from the blue cable (BU/0 V) on the receiver. The green and yellow LED indicators flash alternately at 2.5 Hz
3. The end of the Teach-in process is indicated when the green LED indicator lights up static and yellow LED blinks.

Two-Point Teach-In

When using this Teach-in method, the following settings are made on the thru-beam sensor:

- The gain is set to an optimum value
- The signal threshold is set in the center between the two taught signal values

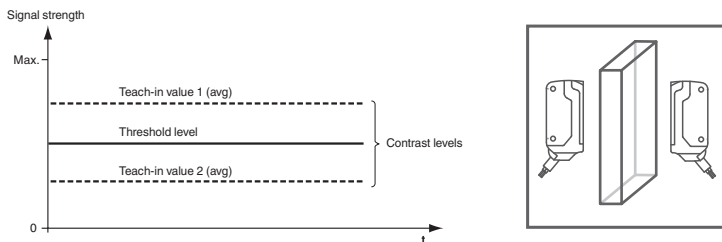

1. Make sure that there are no objects in the beam path and that the sensor is connected to the power supply.
2. Connect the white cable on the receiver (WH/IN) to the blue cable (BU/0 V) on the receiver. The green and yellow LED indicators flash simultaneously at 2.5 Hz
3. Position the object in the beam path.
4. Disconnect the white cable on the receiver (WH/IN) from the blue cable (BU/0 V) on the receiver. The green and yellow LED indicators flash alternately at 2.5 Hz
5. The end of the Teach-in process is indicated when the green LED indicator lights up static.

Maximum Teach-In

When using this Teach-in method, the following settings are made on the thru-beam sensor:

- The gain is set to a maximum
- The signal threshold is set to a minimum

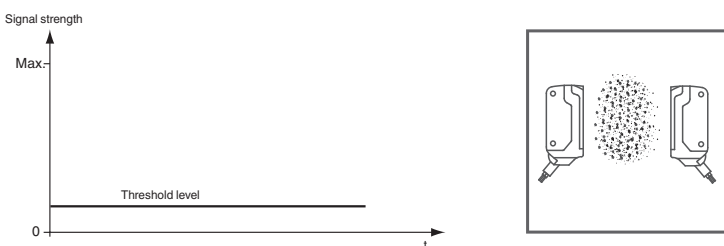

Recommended application:

Enables an object to be detected with a high excess gain. This can be useful if there is severe environmental contamination or to achieve long operating times.

Make sure that there are no objects in the beam path and that the sensor is connected to the power supply.

6. Cover the receiver or transmitter.
7. Connect the white cable on the receiver (WH/IN) to the blue cable (BU/0 V) on the receiver.

Release date: 2023-04-05 Date of issue: 2023-04-05 Filename: 280472_eng.pdf

Thru-beam sensor (pair)

OBE500-R2F-SE0-L

The green and yellow LED indicators flash simultaneously at 2.5 Hz

8. Disconnect the white cable on the receiver (WH/IN) from the blue cable (BU/0 V) on the receiver.
The green and yellow LED indicators flash alternately at 2.5 Hz
9. The end of the Teach-in process is indicated when the green LED indicator lights up static.