

Female cordset

V3-WM-20M-PVC

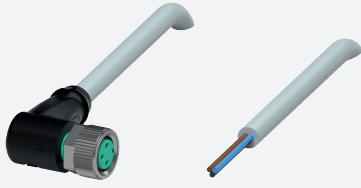

- Degree of protection IP68
- Specific design protects against loosening and inaccurate installation

Female cordset single-ended M8 angled A-coded, 3-pin, PVC cable grey



Dimensions

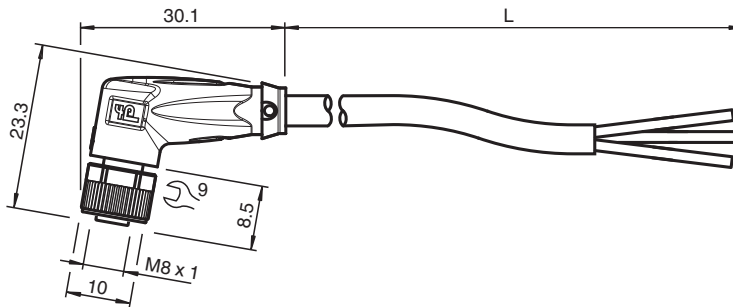

Technical Data

General specifications

| | |
|-------------------|------------------|
| Connector 1 | |
| Connection | socket |
| Construction type | M8 |
| Style | angled |
| Locking | screw connection |
| Number of pins | 3 |
| Coding | A-coded |
| Connector 2 | |
| Connection | cable end |

Electrical specifications

| | | |
|-------------------|-------|------------------------|
| Operating voltage | U_B | max. 48 V AC / 60 V DC |
| Operating current | I_B | max. 3 A |

Conformity

| | |
|----------------------|------------------------------------|
| Degree of protection | EN 60529 |
| Plug connection | connector M8 x 1 : IEC 61076-2-104 |

Ambient conditions

| | |
|---------------------|--------------------------------|
| Ambient temperature | |
| Plug connector | -40 ... 90 °C (-40 ... 194 °F) |
| Cable, fixed | -40 ... 70 °C (-40 ... 158 °F) |
| Cable, flexing | -5 ... 70 °C (23 ... 158 °F) |
| Pollution degree | 3 |

Release date: 2023-09-04 Date of issue: 2023-09-04 Filename: 231394_eng.pdf

Refer to "General Notes Relating to Pepperl+Fuchs Product Information".



Technical Data

| Mechanical specifications | | |
|--------------------------------------------------|---|---------------------------------------------------------------|
| Plug connector | | |
| Tightening torque | | 0.4 Nm |
| Loosening protection | | available |
| Tool installation | | straight knurling and hexagon nut SW = 9 mm |
| Mating cycles | | min. 100 |
| Degree of protection | | IP68 |
| Cable | | |
| according to IEC/EN 60228 (DIN VDE 0295) class 5 | | |
| Sheath diameter | | 4.3 mm |
| Bending radius | | > 15 x cable diameter, moving > 10 x cable diameter, fixed |
| Sheath stripping force | | max. 80 N / 300 mm |
| Sheath color | | grey (similar to RAL 7001) |
| Number of cores | | 3 |
| Core cross section | | 0.25 mm ² |
| Cores color | | Core 1: brown Core 3: blue Core 4: black |
| Core construction | | 14 x 0.15 mm Ø |
| Length | L | 20 m |
| Cable code | | Li YY 3 x 0,25 |
| Material | | |
| Plug connector | | |
| Screw connection | | Zinc diecast, nickel-plated |
| Body | | TPU, black |
| Seal | | FKM |
| Contact surface | | gold plated (Au) |
| Flammability | | V-2 |
| Cable | | |
| Sheathing | | PVC |
| Core insulation | | PVC |
| Flammability | | flame-resistant |

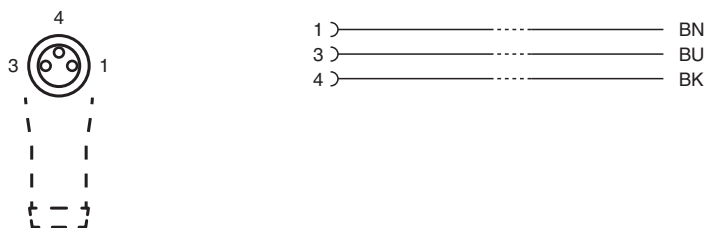

Connection



Accessories

| | | |
|-------------------------------------------------------------------------------------|--------------------------|-----------------------------|
|  | MH V3-SCREWDRIVER | Torque screwdriver (0.4 Nm) |
|  | MH V3-BIT M8 | plug-in cap for M8 |
|  | V1/V3-LABELHOLDER | Label holder |

Accessories

| | | |
|-----------------------------------------------------------------------------------|----------------------------|---------------------------------------------------|
|  | <p>V1/V3-LABEL</p> | <p>Label plate</p> |
|  | <p>MH V3-Holder</p> | <p>Modular universal holder for M8 connectors</p> |

Release date: 2023-09-04 Date of issue: 2023-09-04 Filename: 231394_eng.pdf

Refer to "General Notes Relating to Pepperl+Fuchs Product Information".

Pepperl+Fuchs Group
www.pepperl-fuchs.com

USA: +1 330 486 0001
fa-info@us.pepperl-fuchs.com

Germany: +49 621 776 1111
fa-info@de.pepperl-fuchs.com

Singapore: +65 6779 9091
fa-info@sg.pepperl-fuchs.com