



Ultrasonic sensor

UB6000-30GM-H3-V1

- Separate evaluation
- Direct detection mode

Single head system



Dimensions

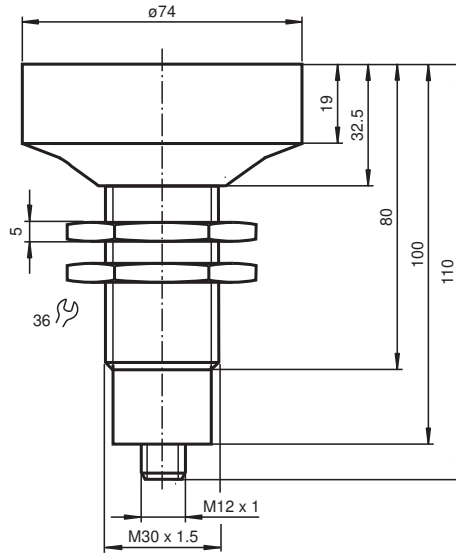

Technical Data

General specifications

Sensing range	350 ... 6000 mm
Adjustment range	400 ... 6000 mm
Dead band	0 ... 350 mm ¹⁾
Standard target plate	100 mm x 100 mm
Transducer frequency	approx. 65 kHz

Electrical specifications

Operating voltage	U_B	10 ... 30 V DC , ripple 10 % _{SS}
No-load supply current	I_0	≤ 30 mA

Input

Release date: 2023-02-15 Date of issue: 2023-02-15 Filename: 130479_eng.pdf

Refer to "General Notes Relating to Pepperl+Fuchs Product Information".

Pepperl+Fuchs Group
www.pepperl-fuchs.com

USA: +1 330 486 0001
fa-info@us.pepperl-fuchs.com

Germany: +49 621 776 1111
fa-info@de.pepperl-fuchs.com

Singapore: +65 6779 9091
fa-info@sg.pepperl-fuchs.com

pf PEPPERL+FUCHS

Technical Data

Input type		1 pulse input for transmitter pulse (clock) 0-level (active): < 5 V ($U_B > 15 V$) 1-level (inactive): > 10 V ... + U_B ($U_B > 15 V$) 0-level (active): < 1/3 U_B ($10 V < U_B < 15 V$) 1-level (inactive): > 2/3 U_B ... + U_B ($10 V < U_B < 15 V$)
Pulse length		50 ... 700 μs (typ. 500 μs) ²⁾
Pause length		$\geq 50 \times$ pulse length
Impedance		10 kOhm internal connected to + U_B
Output		
Output type		1 pulse output for echo run time, short-circuit proof open collector PNP with pulldown resistor = 22 kOhm level 0 (no echo): - U_B level 1 (echo detected): $\geq (+U_B - 2 V)$
Rated operating current	I_e	15 mA , short-circuit/overload protected
Temperature influence		the echo propagation time: 0.17 % / K
Compliance with standards and directives		
Standard conformity		
Standards		EN IEC 60947-5-2:2020 IEC 60947-5-2:2019
Approvals and certificates		
UL approval		cULus Listed, General Purpose
CCC approval		CCC approval / marking not required for products rated $\leq 36 V$
Ambient conditions		
Ambient temperature		-25 ... 85 °C (-13 ... 185 °F)
Storage temperature		-40 ... 85 °C (-40 ... 185 °F)
Mechanical specifications		
Connection type		Connector plug M12 x 1 , 4-pin
Housing diameter		74 mm
Degree of protection		IP67
Material		
Housing		nickel plated brass; plastic components: PBT
Transducer		epoxy resin/hollow glass sphere mixture; polyurethane foam
Mass		250 g

Connection

Standard symbol/Connection:

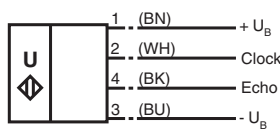

2 = Emitter pulse input
4 = Echo propagation time output
Core colours in accordance with EN 60947-5-2.

Connection Assignment

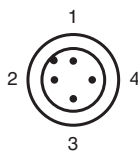

Release date: 2023-02-15 Date of issue: 2023-02-15 Filename: 130479_eng.pdf

Refer to "General Notes Relating to Pepperl+Fuchs Product Information".

Connection Assignment

Wire colors in accordance with EN 60947-5-2





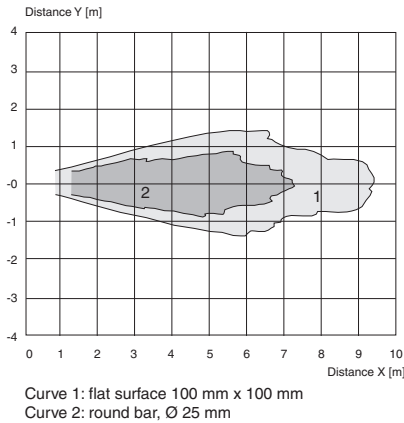

1	BN	(brown)
2	WH	(white)
3	BU	(blue)
4	BK	(black)

Characteristic Curve

Characteristic response curves



Accessories

	BF 30	Mounting flange, 30 mm
	BF 5-30	Universal mounting bracket for cylindrical sensors with a diameter of 5 ... 30 mm
	V1-G-2M-PVC	Female cordset single-ended M12 straight A-coded, 4-pin, PVC cable grey
	UVW90-M30	Ultrasonic -deflector
	UVW90-K30	Ultrasonic -deflector
	M30K-VE	Plastic nuts with centering ring for the vibration-free mounting of cylindrical sensors

Release date: 2023-02-15 Date of issue: 2023-02-15 Filename: 130479_eng.pdf

Function Principle

The sensing range is determined in the downstream evaluation electronics such as PLC modules or other existing evaluation units.

The object distance in pulse-echo mode is obtained from the echo time Δt . The emission of an ultrasonic pulse starts simultaneously with the falling slope of the clock input signal.

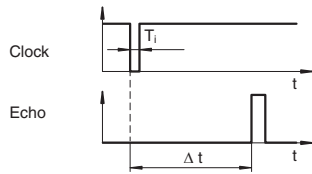

We recommend the usage of a npn-transistor to trigger the sensors clock input. The sensors clock input is connected to the $+U_B$ potential internally by means of a pull up resistor.

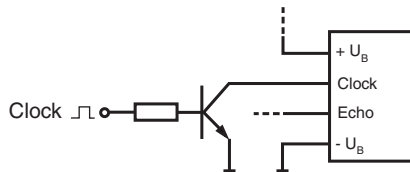

- 1) The unusable area (blind range) BR depends on the pulse duration T_i .
The unusable area reaches a minimum with the shortest pulse duration.
- 2) The sensors detection range depends on the pulse duration T_i .
With pulse duration < typical pulse duration, the sensors detection range may be reduced.

Release date: 2023-02-15 Date of issue: 2023-02-15 Filename: 130479_eng.pdf