



Triangulation sensor (BGS)

OBT80-R2-E2-P-L



- High-performance miniature photoelectric sensors
- DuraBeam Laser Sensors - durable and employable like an LED
- 45° cable outlet for maximum mounting freedom under extremely tight space constraints
- Precision object detection, almost irrespective of the color

Laser triangulation sensor with background suppression, ultra-small design with M2 mounting, 80 mm sensing range, light on, PNP output, 2 m fixed cable



Function

The R2 series nano sensor has been developed for a broad range of applications. It offers excellent durability and is exceptionally easy to install. The housing is compact and, with its 45° cable outlet, can be installed in the smallest spaces. New functional principles and functionality open up a range of new options. The DuraBeam laser sensors are durable and can be used in the same way as a standard sensor.

Dimensions

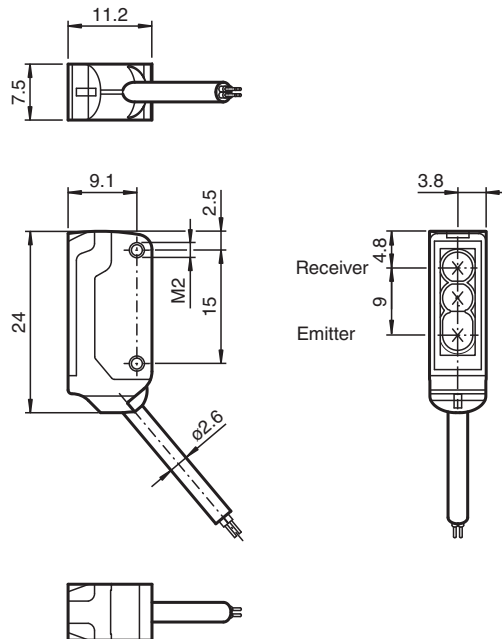

Technical Data

General specifications

| | |
|------------------|--------------------------------------|
| Detection range | 20 ... 80 mm |
| Reference target | standard black, 100 mm x 100 mm |
| Light source | laser diode |
| Light type | modulated visible red light , 680 nm |

Release date: 2023-04-05 Date of issue: 2023-04-05 Filename: 70141926_eng.pdf

Refer to "General Notes Relating to Pepperl+Fuchs Product Information".

Pepperl+Fuchs Group
www.pepperl-fuchs.com

USA: +1 330 486 0001
fa-info@us.pepperl-fuchs.com

Germany: +49 621 776 1111
fa-info@de.pepperl-fuchs.com

Singapore: +65 6779 9091
fa-info@sg.pepperl-fuchs.com

PF PEPPERL+FUCHS

Technical Data

| | | |
|---|----------------|--|
| Laser nominal ratings | | |
| Note | | LASER LIGHT , DO NOT STARE INTO BEAM |
| Laser class | | 1 |
| Wave length | | 680 nm |
| Beam divergence | | > 5 mrad |
| Pulse length | | approx. 3 µs |
| Repetition rate | | approx. 16.6 kHz |
| max. pulse energy | | 9.5 nJ |
| Black-white difference (6 %/90 %) | | < 15 % at 80 mm |
| Diameter of the light spot | | approx. 2 mm at a distance of 80 mm |
| Opening angle | | approx. 2 ° |
| Optical face | | frontal |
| Ambient light limit | | EN 60947-5-2 : 30000 Lux |
| Functional safety related parameters | | |
| MTTF _d | | 800 a |
| Mission Time (T _M) | | 20 a |
| Diagnostic Coverage (DC) | | 0 % |
| Indicators/operating means | | |
| Operation indicator | | LED green, statically lit Power on , short-circuit : LED green flashing (approx. 4 Hz) |
| Function indicator | | LED yellow: lights when object is detected |
| Electrical specifications | | |
| Operating voltage | U _B | 12 ... 24 V |
| No-load supply current | I ₀ | < 10 mA |
| Protection class | | III |
| Output | | |
| Switching type | | NO contact / light-on |
| Signal output | | 1 PNP output, short-circuit protected, reverse polarity protected, open collector |
| Switching voltage | | max. 30 V DC |
| Switching current | | max. 50 mA , resistive load |
| Voltage drop | U _d | ≤ 1.5 V DC |
| Switching frequency | f | approx. 2 kHz |
| Response time | | 250 µs |
| Conformity | | |
| Product standard | | EN 60947-5-2 |
| Laser safety | | EN 60825-1:2007 |
| Approvals and certificates | | |
| UL approval | | E87056 , cULus Recognized, Class 2 Power Source |
| CCC approval | | CCC approval / marking not required for products rated ≤36 V |
| FDA approval | | IEC 60825-1:2007 Complies with 21 CFR 1040.10 and 1040.11 except for deviations pursuant to Laser Notice No. 50, dated June 24, 2007 |
| Ambient conditions | | |
| Ambient temperature | | -20 ... 60 °C (-4 ... 140 °F) |
| Storage temperature | | -30 ... 70 °C (-22 ... 158 °F) |
| Mechanical specifications | | |
| Housing width | | 7.5 mm |
| Housing height | | 24 mm |
| Housing depth | | 11.2 mm |
| Degree of protection | | IP67 |
| Connection | | 2 m fixed cable |
| Material | | |
| Housing | | PC/ABS and TPU |
| Optical face | | PC |
| Cable | | PUR |

Release date: 2023-04-05 Date of issue: 2023-04-05 Filename: 70141926_eng.pdf

Technical Data

| | |
|--------------|---|
| Installation | Fixing screws , 2 x M2 allen head screws included with delivery |
| Mass | approx. 20 g |
| Cable length | 2 m |

Connection

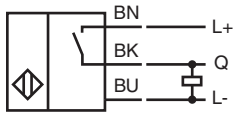

Assembly

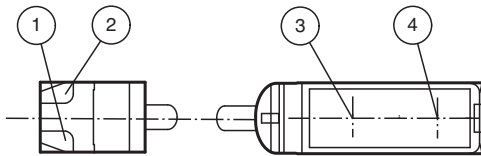

| | | |
|---|-------------------|--------|
| 1 | Operating display | green |
| 2 | Signal display | yellow |
| 3 | Emitter | |
| 4 | Receiver | |

Characteristic Curve

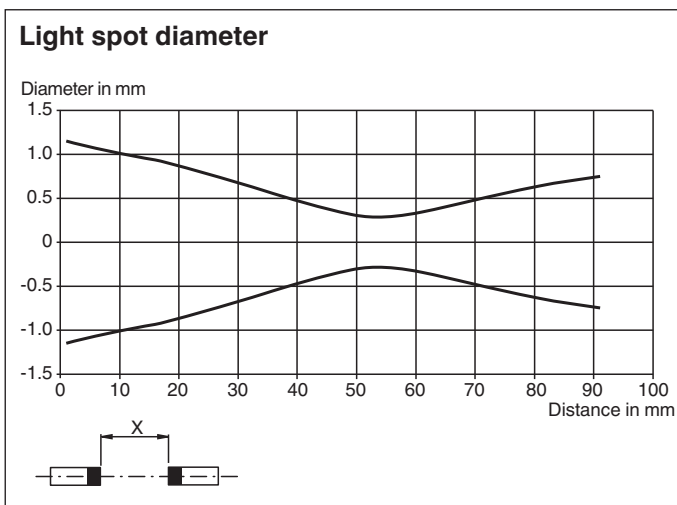

Release date: 2023-04-05 Date of issue: 2023-04-05 Filename: 70141926_eng.pdf

Characteristic Curve

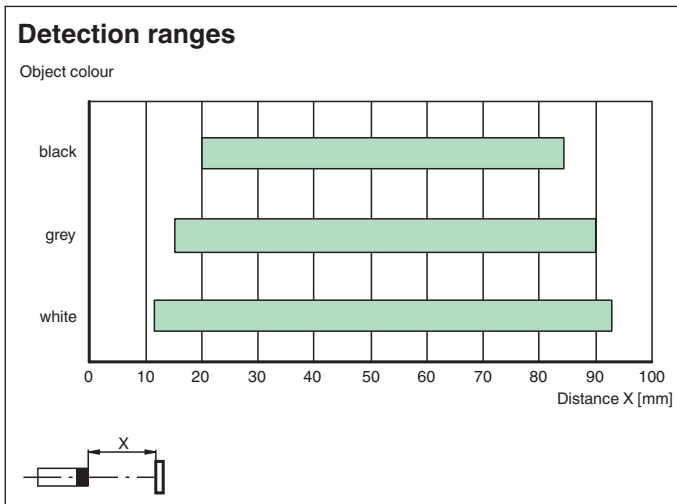

Safety Information



Safety Information

Laser Class 1 Information

The irradiation can lead to irritation especially in a dark environment. Do not point at people!

Maintenance and repairs should only be carried out by authorized service personnel!

Attach the device so that the warning is clearly visible and readable.

The warning accompanies the device and should be attached in immediate proximity to the device.

Caution – Use of controls or adjustments or performance of procedures other than those specified herein may result in hazardous radiation exposure.

Accessories

| | | |
|--|-----------------|--|
| | MH-R2-01 | Mounting aid for R2 series, Mounting bracket |
| | MH-R2-02 | Mounting aid for R2 series, Mounting bracket |

Release date: 2023-04-05 Date of issue: 2023-04-05 Filename: 70141926_eng.pdf

Refer to "General Notes Relating to Pepperl+Fuchs Product Information".

Pepperl+Fuchs Group
www.pepperl-fuchs.com



USA: +1 330 486 0001
fa-info@us.pepperl-fuchs.com

Germany: +49 621 776 1111
fa-info@de.pepperl-fuchs.com

Singapore: +65 6779 9091
fa-info@sg.pepperl-fuchs.com

PEPPERL+FUCHS

Accessories

| | | |
|---|------------------------|---|
|  | <p>MH-R2-03</p> | <p>Mounting aid for R2 series, Mounting bracket</p> |
|  | <p>MH-R2-04</p> | <p>Mounting aid for R2 series, Mounting bracket</p> |

Release date: 2023-04-05 Date of issue: 2023-04-05 Filename: 70141926_eng.pdf

Refer to "General Notes Relating to Pepperl+Fuchs Product Information".

Pepperl+Fuchs Group
www.pepperl-fuchs.com

USA: +1 330 486 0001
fa-info@us.pepperl-fuchs.com

Germany: +49 621 776 1111
fa-info@de.pepperl-fuchs.com

Singapore: +65 6779 9091
fa-info@sg.pepperl-fuchs.com