



Retroreflective sensor (glass)

OBG3500-18GK40-E0-V1



- Short design in M18 plastic housing
- Sensitivity adjuster for optimal adaptation to the application
- Not sensitive to ambient light
- Degree of protection IP67
- Very high detection range

Retroreflective sensor (glass)



Function

The optical sensors of this series have an M18 threaded housing that is optionally available in plastic or metal. The sensors are robust and versatile. Focusing on the essential requirements simplifies selection and commissioning, saving time and costs.

Dimensions

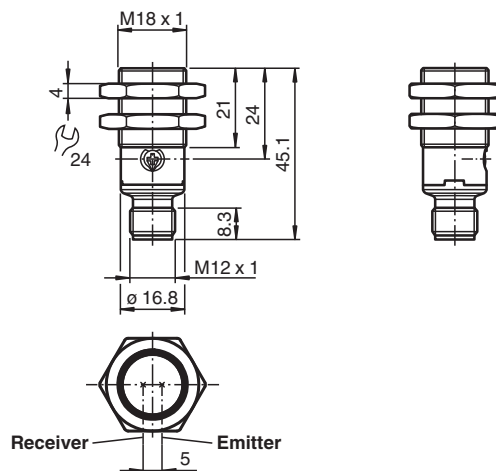

Technical Data

General specifications

Effective detection range	0 ... 3.5 m in glass mode;
Reflector distance	0 ... 3.5 m in glass mode;
Threshold detection range	3.5 m
Reference target	reflector C110-2
Light source	LED
Light type	modulated visible red light
Polarization filter	yes
Diameter of the light spot	approx. 190 mm at a distance of 3.5 m
Angle of divergence	approx. 2.6 °

Technical Data

Optical face		frontal
Ambient light limit		EN 60947-5-2 20000 Lux
Functional safety related parameters		
MTTF _d		904 a
Mission Time (T _M)		20 a
Diagnostic Coverage (DC)		0 %
Indicators/operating means		
Operation indicator		LED green: on - power on flashing (4 Hz) - short circuit
Function indicator		Yellow LED: Permanently lit - light path clear Permanently off - object detected Flashing (4 Hz) - insufficient operating reserve
Control elements		potentiometer for Teach-In
Contrast detection levels		18 % - clear glass bottles 40 % - colored glass or opaque materials
Electrical specifications		
Operating voltage	U _B	10 ... 30 V DC
Ripple		max. 10 %
No-load supply current	I ₀	< 25 mA
Protection class		III
Output		
Switching type		Q - Pin4: NPN normally open / dark-on
Signal output		1 NPN output, short-circuit protected, reverse polarity protected, open collector
Switching voltage		max. 30 V DC
Switching current		max. 100 mA , resistive load
Voltage drop	U _d	≤ 1.5 V DC
Switching frequency	f	500 Hz
Response time		≤ 1 ms
Conformity		
Product standard		EN 60947-5-2
Approvals and certificates		
UL approval		E87056 , cULus Listed , class 2 power supply , type rating 1
Ambient conditions		
Ambient temperature		-40 ... 60 °C (-40 ... 140 °F)
Storage temperature		-40 ... 70 °C (-40 ... 158 °F)
Mechanical specifications		
Degree of protection		IP67
Connection		3-pin, M12 x 1 connector
Material		
Housing		PC (Polycarbonate)
Optical face		PMMA
Connector		Plastic
Mass		approx. 8 g

Connection

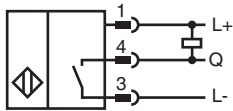

Connection Assignment

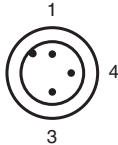

Wire colors in accordance with EN 60947-5-2

1	BN	(brown)
3	BU	(blue)
4	BK	(black)

Indication

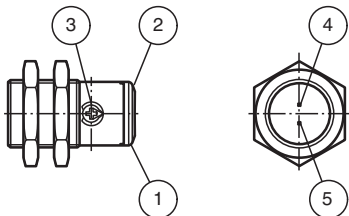

1	Operating display	green
2	Signal display	yellow
3	Teach-In and Mode selection	
4	Emitter	
5	Receiver	

Characteristic Curve

Characteristic response curve

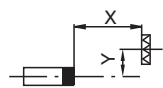
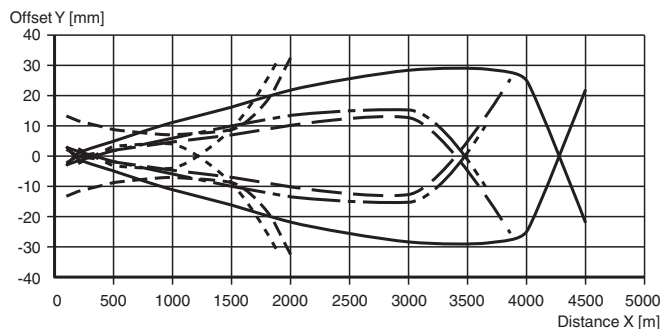

—	H85-2	- - -	VR10
- - -	C110-2	- · - · -	Foil 100/100
- · - · -	H50		

Release date: 2021-06-28 Date of issue: 2021-06-28 Filename: 70113328-100007_eng.pdf

Refer to "General Notes Relating to Pepperl+Fuchs Product Information".

Pepperl+Fuchs Group
www.pepperl-fuchs.com

USA: +1 330 486 0001
fa-info@us.pepperl-fuchs.com

Germany: +49 621 776 1111
fa-info@de.pepperl-fuchs.com

Singapore: +65 6779 9091
fa-info@sg.pepperl-fuchs.com

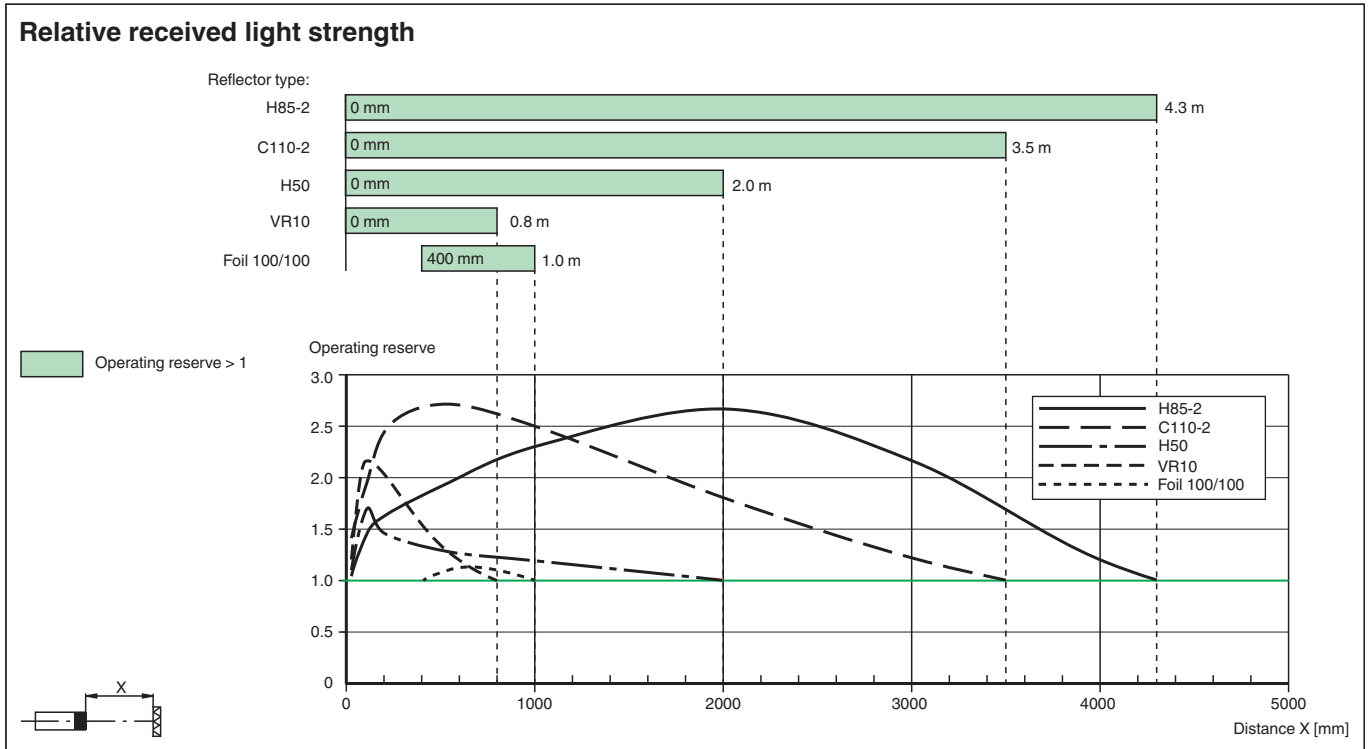

Teach-In

Apply the operating voltage to the sensor. The operating indicator lights up green. The sensor is automatically set to the last teach-in setting. Mount a suitable reflector opposite the sensor. The reflector can be taught-in in teach-in mode.

Switch position	Description
T	Teach-in mode
CI	Contrast 1
CII	Contrast 2

Teach-in mode:

- To start the teach-in mode, set the switch to the "T" position when light beam is free (no target).
- Wait approx. 3 seconds until the yellow and green signal indicators flash slowly and simultaneously (2.5 Hz).
- Turn the switch to contrast I or contrast II.

To indicate the end of the teach-in mode, the yellow and green signal indicators flash alternately for approx. 5 seconds.

- **Teach-in successful:** The green and yellow signal indicators flash slowly and alternately (2.5 Hz) for approximately 5 seconds. The contrast selected will be activated. The yellow signal indicator lights up permanently. The sensor is ready for operation.
- **Teach-in unsuccessful:** The green and yellow signal indicators flash quickly and alternately (8 Hz) for approx. 5 seconds. The contrast selected will be activated. The sensor is set to the previous valid teach-in setting.