



Distance sensor

OMT600-R201-IEP-IO-0,3M-V1-L



- Medium design with versatile mounting options
- Space-saving distance sensors in small standardized design
- Multi Pixel Technology (MPT) - exact and precise signal evaluation
- IO-Link interface for service and process data
- Analog output 4 ... 20 mA

Distance sensor



IO-Link

Function

The optical sensors in the series are the first devices to offer an end-to-end solution in a medium-sized standard design – from the thru-beam sensor through to the measuring distance sensor. As a result of this design, the sensors are able to perform practically all standard automation tasks.

The entire series enables sensors to communicate via IO-Link.

The DuraBeam laser sensors are durable and can be used in the same way as a standard sensor.

Multi Pixel Technology (MPT) ensures that the standard sensors are flexible and can be adapted to the application environment.

Dimensions

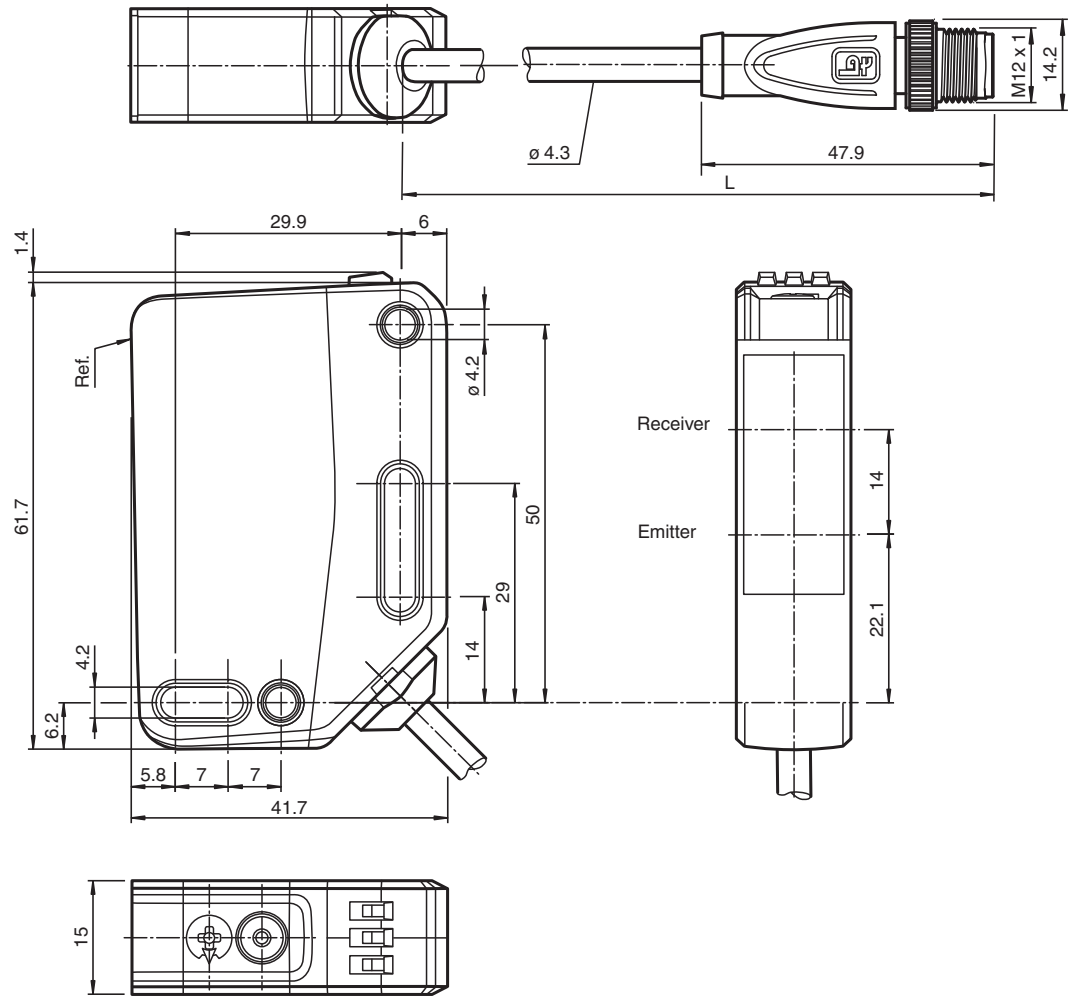

Technical Data

| General specifications | |
|--------------------------------------|--|
| Measurement range | 100 ... 600 mm |
| Reference target | standard white, 100 mm x 100 mm |
| Light source | laser diode |
| Light type | modulated visible red light |
| Laser nominal ratings | |
| Note | LASER LIGHT , DO NOT STARE INTO BEAM |
| Laser class | 1 |
| Wave length | 680 nm |
| Beam divergence | > 5 mrad, d63 < 2,8 mm in the range of 350 mm ... 800 mm |
| Pulse length | 5.5 µs |
| Repetition rate | approx. 2.4 kHz |
| max. pulse energy | < 40 nJ |
| Angle deviation | max. +/- 1.5 ° |
| Diameter of the light spot | approx. 3 mm at a distance of 600 mm |
| Opening angle | approx. 0.3 ° |
| Ambient light limit | EN 60947-5-2 : 15000 Lux |
| Resolution | 0.1 mm |
| Functional safety related parameters | |
| MTTF _d | 470 a |
| Mission Time (T _M) | 20 a |

Release date: 2023-01-16 Date of issue: 2023-01-16 Filename: 295670-100343_eng.pdf

Refer to "General Notes Relating to Pepperl+Fuchs Product Information".

Technical Data

| | | |
|-----------------------------------|-------|--|
| Diagnostic Coverage (DC) | | 0 % |
| Indicators/operating means | | |
| Operation indicator | | LED green: constantly on - power on flashing (4Hz) - short circuit flashing with short break (1 Hz) - IO-Link mode |
| Function indicator | | LED yellow: constantly on - switch output active constantly off - switch output inactive |
| Control elements | | Teach-In key |
| Control elements | | 5-step rotary switch for operating modes selection |
| Electrical specifications | | |
| Operating voltage | U_B | 18 ... 30 V DC |
| Ripple | | max. 10 % |
| No-load supply current | I_0 | < 18 mA at 24 V supply voltage |
| Protection class | | III |
| Interface | | |
| Interface type | | IO-Link (via C/Q = pin 4) |
| IO-Link revision | | 1.1 |
| Device profile | | Identification and diagnosis Smart Sensor type 0/type 3.3 |
| Device ID | | 0x111918 (1120536) |
| Transfer rate | | COM2 (38.4 kBit/s) |
| Min. cycle time | | 3 ms |
| Process data width | | Process data input 4 byte Process data output 2 bits |
| SIO mode support | | yes |
| Compatible master port type | | A |
| Output | | |
| Switching type | | The default setting is: C/Q - Pin4: NPN normally open, PNP normally closed, IO-Link I—Pin2: analog output 4...20 mA |
| Signal output | | 1 push-pull output , 1 analog output , short-circuit-proof, reverse polarity protection, surge-proof |
| Switching voltage | | max. 30 V DC |
| Switching current | | max. 100 mA , resistive load |
| Usage category | | DC-12 and DC-13 |
| Voltage drop | U_d | ≤ 1.5 V DC |
| Response time | | 2 ms |
| Analog output | | |
| Output type | | 1 current output: 4 ... 20 mA |
| Load resistor | | > 1 kΩ voltage output ; ≤ 470 Ω current output |
| Recovery time | | 2 ms |
| Conformity | | |
| Communication interface | | IEC 61131-9 |
| Product standard | | EN 60947-5-2 |
| Laser safety | | EN 60825-1:2014 |
| Measurement accuracy | | |
| Temperature drift | | 0.05 %/K |
| Warm up time | | 5 min |
| Repeat accuracy | | < 1 % |
| Linearity error | | 0.75 % |
| Approvals and certificates | | |
| UL approval | | E87056 , cULus Listed , class 2 power supply , type rating 1 |
| CCC approval | | CCC approval / marking not required for products rated ≤36 V |
| FDA approval | | IEC 60825-1:2014 Complies with 21 CFR 1040.10 and 1040.11 except for deviations pursuant to Laser Notice No. 50, dated June 24, 2007 |

Release date: 2023-01-16 Date of issue: 2023-01-16 Filename: 295670-100343_eng.pdf

Refer to "General Notes Relating to Pepperl+Fuchs Product Information".

Pepperl+Fuchs Group
www.pepperl-fuchs.comUSA: +1 330 486 0001
fa-info@us.pepperl-fuchs.comGermany: +49 621 776 1111
fa-info@de.pepperl-fuchs.comSingapore: +65 6779 9091
fa-info@sg.pepperl-fuchs.com

PEPPERL+FUCHS

Technical Data

Ambient conditions

| | |
|---------------------|--------------------------------|
| Ambient temperature | 10 ... 50 °C (50 ... 122 °F) |
| Storage temperature | -40 ... 70 °C (-40 ... 158 °F) |

Mechanical specifications

| | |
|----------------------|--|
| Housing width | 15 mm |
| Housing height | 61.7 mm |
| Housing depth | 41.7 mm |
| Degree of protection | IP67 / IP69 / IP69K |
| Connection | 300 mm fixed cable with M12 x 1, 4-pin connector |
| Material | |
| Housing | PC (Polycarbonate) |
| Optical face | PMMA |
| Mass | approx. 55 g |
| Cable length | 0.3 m |

Connection

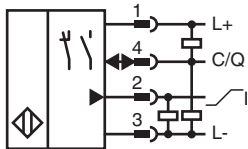

Connection Assignment

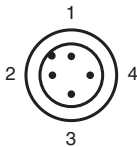

Wire colors in accordance with EN 60947-5-2

| | | |
|---|----|---------|
| 1 | BN | (brown) |
| 2 | WH | (white) |
| 3 | BU | (blue) |
| 4 | BK | (black) |

Assembly

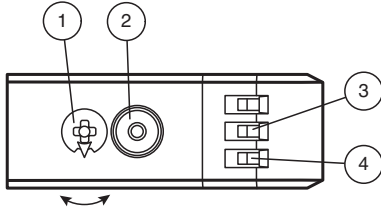

| | | |
|---|-----------------------------|----|
| 1 | Mode rotary switch | |
| 2 | Teach-in button | |
| 3 | Switching output display Q1 | YE |
| 4 | Operating indicator | GN |

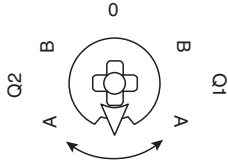

| | |
|-----|---------------------------------|
| Q1B | Switching output/switch point B |
| Q1A | Switching output/switch point A |
| Q2A | Analog output/value A |
| Q2B | Analog output/value B |
| 0 | Keylock |

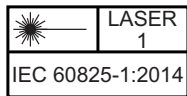





Accessories

| | | |
|--|-----------------------------|---|
| | V1-G-2M-PUR | Female cordset single-ended M12 straight A-coded, 4-pin, PUR cable grey |
| | V1-W-2M-PUR | Female cordset single-ended M12 angled A-coded, 4-pin, PUR cable grey |
| | OMH-RL31-02 | Mounting bracket narrow |
| | OMH-RL31-03 | Mounting bracket narrow |
| | OMH-RL31-04 | Mounting aid for round steel ø 12 mm or sheet 1.5 mm ... 3 mm |
| | OMH-RL31-07 | Mounting bracket including adjustment |
| | OMH-R20x-Quick-Mount | Quick mounting accessory |
| | ICE2-8IOL-G65L-V1D | EtherNet/IP IO-Link master with 8 inputs/outputs |
| | ICE3-8IOL-G65L-V1D | PROFINET IO IO-Link master with 8 inputs/outputs |
| | ICE2-8IOL-K45S-RJ45 | EtherNet/IP IO-Link master with 8 inputs/outputs, DIN rail, screw terminal |
| | ICE3-8IOL-K45P-RJ45 | PROFINET IO IO-Link master with 8 inputs/outputs, DIN rail, push-in terminals |
| | ICE3-8IOL-K45S-RJ45 | PROFINET IO IO-Link master with 8 inputs/outputs, DIN rail, screw terminal |

Release date: 2023-01-16 Date of issue: 2023-01-16 Filename: 295670-100343_eng.pdf

Accessories

| | | |
|---|-----------------------------|--|
|  | IO-Link-Master02-USB | IO-Link master, supply via USB port or separate power supply, LED indicators, M12 plug for sensor connection |
|  | ICE1-8IOL-G30L-V1D | Ethernet IO-Link module with 8 inputs/outputs |
|  | ICE1-8IOL-G60L-V1D | Ethernet IO-Link module with 8 inputs/outputs |
|  | ICE2-8IOL-K45P-RJ45 | EtherNet/IP IO-Link master with 8 inputs/outputs, DIN rail, push-in connectors |

Settings

Teach-In (TI)

Use the rotary switch for switching signal **Q1** to select the relevant switching threshold A and/or B to teach in.

- The yellow LEDs indicate the current state of the selected output.

To teach in a switching threshold, press and hold the "TI" button for approximately 1 s, until the yellow and green LEDs flash in phase. Teach-in starts when the "TI" button is released.

- Teach-in successful: the yellow and green LEDs flash alternately at 2.5 Hz.
- Teach-in unsuccessful: the yellow and green LEDs quickly flash alternately at 8 Hz.

After an unsuccessful Teach-in, the sensor continues to operate with the previous valid setting after the relevant visual fault signal is issued.

Set switching mode: you can define different switching modes by teaching in the relevant distance data for switching thresholds A and B.

1. Single point mode:

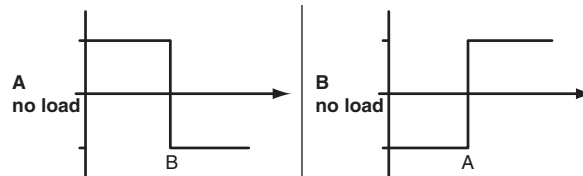

2. Window mode:

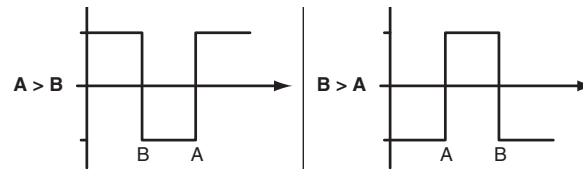

Teach in switching thresholds: you can teach in or overwrite a taught-in switching threshold at any time. To do this, press the "TI" button again.

Reset a value: you can reset a taught-in value. To do this, press the "TI" button for > 4 s, until the yellow and green LEDs go out. The reset process itself starts when the "TI" button is released.

- Reset successful: the yellow and green LEDs flash alternately at 2.5 Hz.

Minimum and maximum values for the analog output Q2 are taught in and deleted in the same way as those for the switching output.

The following applies:

A = Minimum voltage/current

B = Maximum voltage/current

Resetting to Factory Settings

To revert back to factory settings, press the "TI" button for > 10 s with the rotary switch set to position "O," until the yellow and green LEDs go out at the same time. The reset process itself starts when the "TI" button is released.

- Reset to factory settings successful: the yellow and green LEDs light up at the same time. The sensor then continues to operate with factory settings.

OMT-IEP

- Factory setting for switching signal Q1:
Switching signal is high active, window mode
- Analog output: current output, 4 mA ... 20 mA absolute mode

OMT-UEP

- Factory setting for switching signal Q1:
Switching signal is high active, window mode
- Analog output: voltage output, 0 V ... 10 V absolute mode

Analog output

The analog output type can be configured as voltage or current output via IO-Link.

The following output types are available:

- Analog output 0 mA ... 20 mA
- Analog output 4 mA ... 20 mA
- Analog output 0 V ... 10 V

The following operating modes are available:

- Absolute mode (default setting)
- Normalized mode
- Rising slope
- Falling slope

The following substitute values can optionally be configured:

- No substitute values used (default setting)
- Substitute value for "no measured value" used
- Substitute value for "no measured value" and "Measuring overrange" used

The sensor's tolerances are based on the digital process data.

Absolute mode (default setting, A and B = deleted)

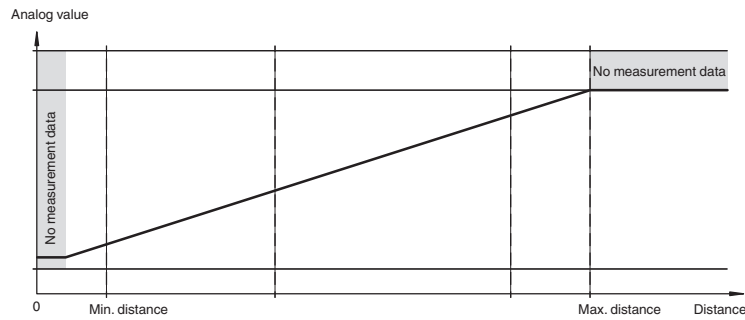

Normal mode (A and B without teach-in / deleted)

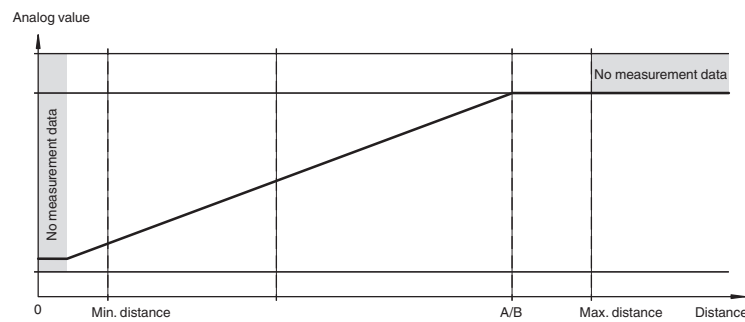

Rising slope (A < B)

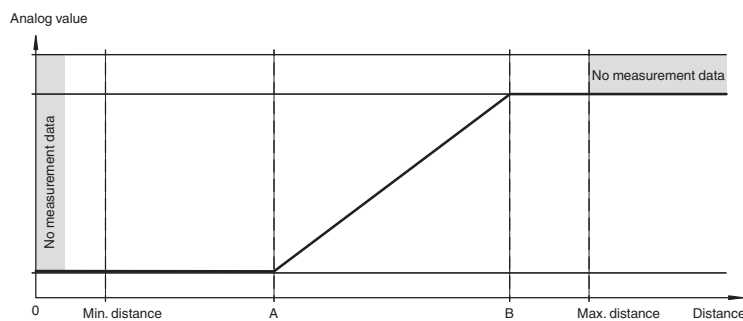

Release date: 2023-01-16 Date of issue: 2023-01-16 Filename: 295670-100343_eng.pdf

Falling slope (A > B)

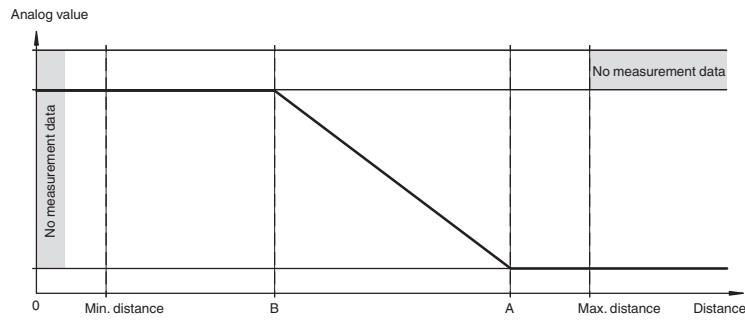

Configuration

Setting different operating modes via the IO-Link interface

The devices are equipped with an IO-Link interface as standard for diagnostics and parameterization tasks to ensure optimum adjustment of the sensors to the relevant application.

Single point mode operating mode (one switch point):

- "Detection of objects irrespective of type and color in a defined detection range. Objects in the background are suppressed.
- "The switch point corresponds exactly to the set point.



Window mode operating mode (two switch points):

- Detection of objects irrespective of type and color in a defined detection range. Reliable detection when object leaves the detection range.
- Window mode with two switch points.



Center window mode operating mode (one switch point):

- Detection of objects irrespective of type and color in a defined detection range. Sets a defined window around a given object. Objects outside this window are not detected.
- Window mode with one switch point.



Two point mode operating mode (hysteresis operating mode):

- Detection of objects irrespective of type and color between a defined switch-on and switch-off point.

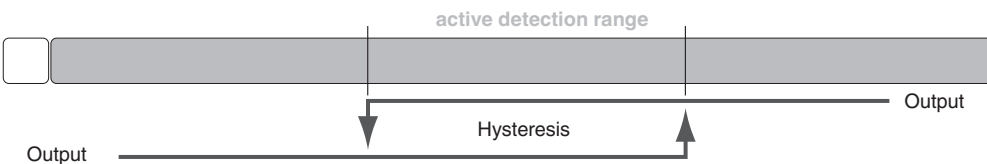

Inactive operating mode:

- Evaluation of switching signals is deactivated.

The associated IODD device description file can be found in the download area at www.pepperl-fuchs.com.

Release date: 2023-01-16 Date of issue: 2023-01-16 Filename: 295670-100343_eng.pdf