

WCS3 code rail

WCS3-CS70-M1-S000000-L010200

- Flexible installation by means of alu profile- or mounting bracket system
- High mechanical stability
- Suitable for applications with wide temperature variations

Code rail, stainless steel

Dimensions

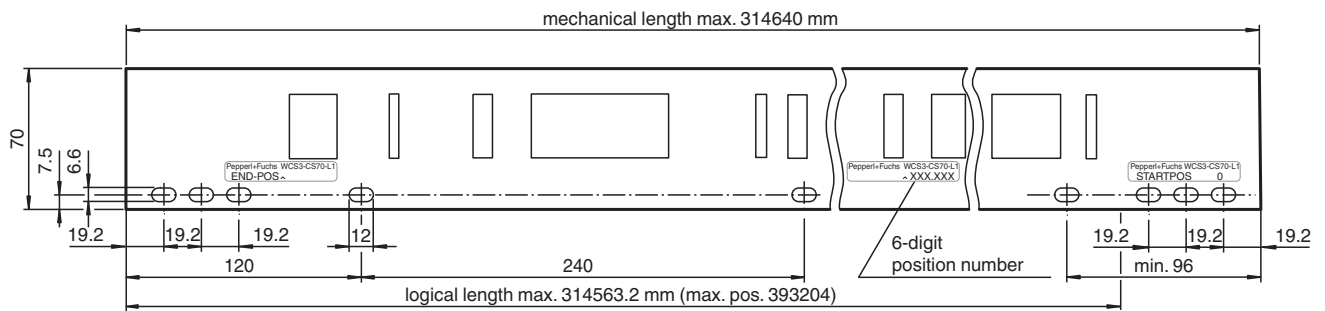

Technical Data

General specifications

Code rail height	70 mm
Total length	10200 mm
Start position	0 mm
Radius of bend	≥ 300 mm

Ambient conditions

Operating temperature	-40 ... 100 °C (-40 ... 212 °F)
Storage temperature	-40 ... 100 °C (-40 ... 212 °F)
Installation temperature	10 ... 60 °C (50 ... 140 °F)

Mechanical specifications

Material thickness	0.5 mm
Tension loading	≤ 5000 N
Material	stainless steel 1.4310 / AISI 301
Thermal expansion coefficient	1.6 x 10 ⁻⁵ / K
Mass	240 g / m
Manufacturing tolerance	± 1 mm/m

Release date: 2023-03-09 Date of issue: 2023-03-09 Filename: 70135878-100012_eng.pdf

Refer to "General Notes Relating to Pepperl+Fuchs Product Information".

Pepperl+Fuchs Group
www.pepperl-fuchs.com

USA: +1 330 486 0001
fa-info@us.pepperl-fuchs.com

Germany: +49 621 776 1111
fa-info@de.pepperl-fuchs.com

Singapore: +65 6779 9091
fa-info@sg.pepperl-fuchs.com

PF PEPPERL+FUCHS

Mounting

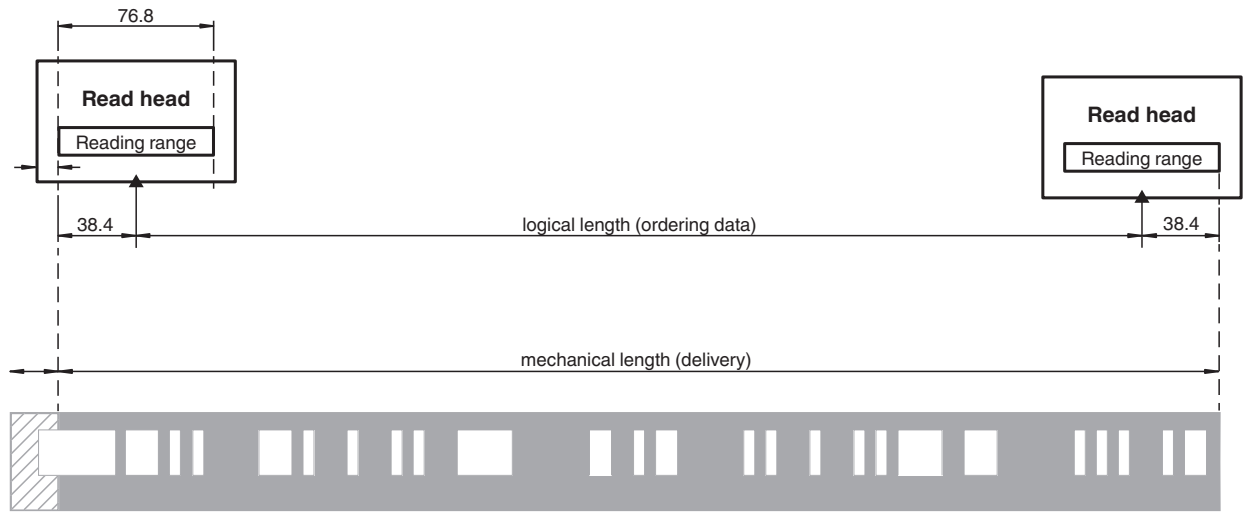

Automatic length correction:
Code rail is only delivered with
web ends or web beginnings

Type Code

Structure of the type code

W	C	S	3	-	C	S	70	-	M	1	-	S	(1)	(1)	(1)	(1)	(1)	(1)	-	L	(2)	(2)	(2)	(2)	(2)	(2)
---	---	---	---	---	---	---	----	---	---	---	---	---	-----	-----	-----	-----	-----	-----	---	---	-----	-----	-----	-----	-----	-----

WCS3	Read head type
WCS	Position encoding system

CS	Code rail
C	Code
S	Rail

70	Code rail height
70	Code rail height



M	Code rail material
M	Stainless steel

1	Mounting hole type
1	With mounting holes

S (1) (1) (1) (1) (1) (1)	Starting position
0 ... 314463	Starting position of the code rail in mm









L (2) (2) (2) (2) (2) (2)	Code rail length
100 ... 314563	Length of the code rail in mm

Accessories

	WCS-MT1	Tensioning device for stainless steel code rail
	WCS-MB2-C	Mounting bracket for C profile, straight section
	WCS-MB1-B	Fastening angle for screw connection, curve

Release date: 2023-03-09 Date of issue: 2023-03-09 Filename: 70135878-100012_eng.pdf

Accessories

	WCS-MB2-B	Mounting bracket for C profile, bend
	WCS-SP2	Stabilization profile
	WCS-MB1	Mounting bracket for bolt connection, straight
	WCS3-CS70-E	WCS3 code rail extender
	WCS-MF1	Wrist strap
	WCS3-FT1	Fitting tool for WCS3 aluminum profile system
	WCS3-MC1	Joint
	WCS3-MH1	WCS3 screw-on holder
	WCS3-MH2	WCS3 holder for C profile
	WCS3-PS1-2M	WCS3 profile rail
	WCS-MB2	Mounting bracket for C profile, straight section
	WCS2-PS1-2,5M	WCS2 profile rail
	WCS3-GT09-P1-O	WCS3 guiding trolley for the WCS3B read head with protective enclosure, outdoor use
	WCS2-MH1	Rail bracket with screwed connection
	WCS2-MC1	Butt connector, aluminum
	WCS2-LB1	WCS2 locking bracket
	WCS2-FT1	Mounting tool to safely and quickly install the 55 mm code strip in the aluminum profile

Release date: 2023-03-09 Date of issue: 2023-03-09 Filename: 70135878-100012_eng.pdf

Refer to "General Notes Relating to Pepperl+Fuchs Product Information".

Pepperl+Fuchs Group
www.pepperl-fuchs.com

USA: +1 330 486 0001
fa-info@us.pepperl-fuchs.com

Germany: +49 621 776 1111
fa-info@de.pepperl-fuchs.com

Singapore: +65 6779 9091
fa-info@sg.pepperl-fuchs.com

 **PEPPERL+FUCHS**