

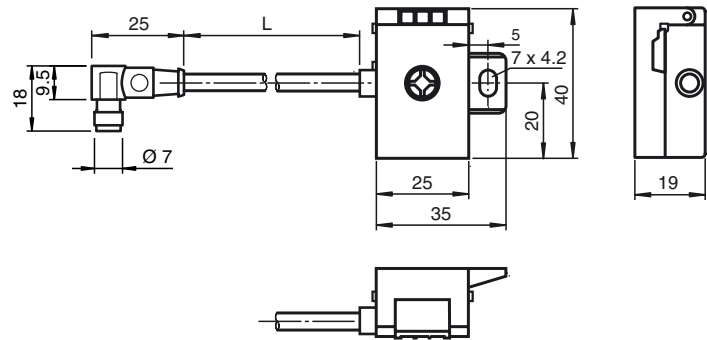

Dimensions



Model number

VAZ-T1-FK-2M-PUR-V3-WR

Splitter box AS-Interface to M8 round connector

Features

- Compact design
- Fixing component with captive screw
- Simple and fast mounting
- Gold plated contacts
- Housing made of fiberglass reinforced plastic
- Reverse polarity protected and yellow marking for AS-Interface flat cable
- Halogen-free

Electrical connection

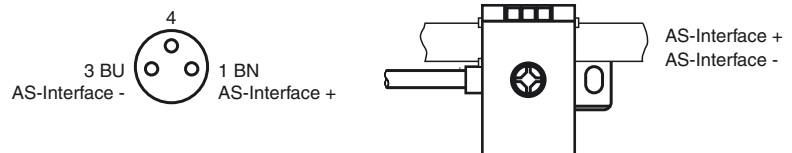

Technical data

General specifications

Construction type	Socket, right-angled AS-Interface flat cable, terminal compartments
-------------------	--

Electrical specifications

Rated operating voltage	$U_e \leq 35 \text{ V PELV (AS-Interface)}$
Rated operating current	$I_e \leq 3 \text{ A}$

Ambient conditions

Ambient temperature	-25 ... 75 °C (-13 ... 167 °F)
Storage temperature	-25 ... 85 °C (-13 ... 185 °F)
Pollution Degree	3

Mechanical specifications

Contact elements	spring-loaded contact socket
Degree of protection	IP67 / IP68 / IP69k
Connection	AS-Interface flat cable: cable piercing method Connector: M8 x 1 (V3)

Material

Contacts	CuSn
Contact surface	Au
Housing	PA 66-GF25 Ultramid
Body	black PUR
Cable	PUR
Cable	fine-strand, flexible
Sheath diameter	Ø 4 mm
Bending radius	> 10 x cable diameter, moving > 5 x cable diameter, dormant
Color	black
Cores	2 x 0.25 mm ²
Length	L 2 m
Tightening torque, fastening screws	1.65 Nm

Compliance with standards and directives

Standard conformity	
Degree of protection	EN 60529:2000