



## Ultrasonic sensor UC3500-30GM70S-2E2R2-V15

- 2 switch outputs
- Synchronization options
- Temperature compensation
- Can be parameterized via the ULTRA-PROG-IR software and interface (accessories)

Ultrasonic diffuse sensor with pivoting transducer



### Dimensions

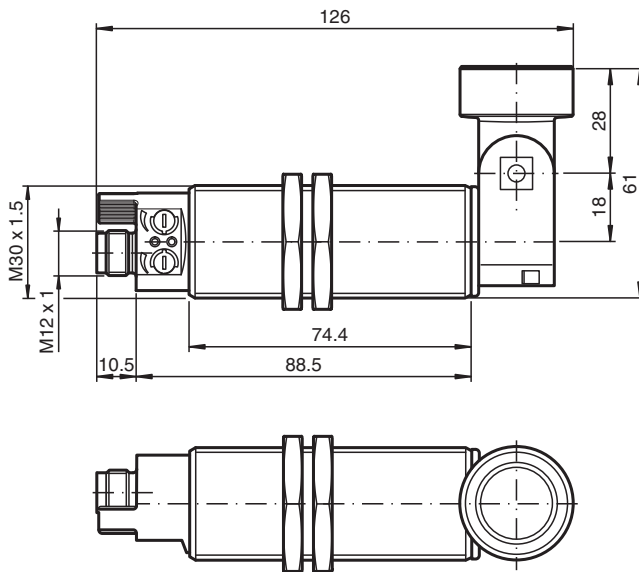

### Technical Data

#### General specifications

Sensing range	200 ... 3500 mm
Adjustment range	300 ... 3500 mm
Dead band	0 ... 200 mm
Standard target plate	100 mm x 100 mm
Transducer frequency	approx. 120 kHz
Response delay	≤ 150 ms

#### Nominal ratings

Temperature drift	≤ ± 1.5 % of full-scale value
Time delay before availability	$t_v$ ≤ 175 ms

Release date: 2023-02-16 Date of issue: 2023-02-16 Filename: 238381\_eng.pdf

Refer to "General Notes Relating to Pepperl+Fuchs Product Information".

Pepperl+Fuchs Group  
www.pepperl-fuchs.com

USA: +1 330 486 0001  
fa-info@us.pepperl-fuchs.com

Germany: +49 621 776 1111  
fa-info@de.pepperl-fuchs.com

Singapore: +65 6779 9091  
fa-info@sg.pepperl-fuchs.com

**PF** PEPPERL+FUCHS

## Technical Data

Limit data		
Permissible cable length		max. 300 m
Indicators/operating means		
LED yellow		solid Switching state switch output 1
LED green/yellow		yellow: switching state switch output 2 green: Teach-In
Potentiometer		Switching output 1 and Switching output 2 adjustable
Electrical specifications		
Rated operating voltage	$U_e$	24 V DC
Operating voltage	$U_B$	12 ... 30 V DC (including ripple)
Ripple		≤ 10 %
No-load supply current	$I_0$	≤ 50 mA
Interface		
Interface type		Infrared
Mode		point-to-point connection
Input/Output		
Input/output type		1 synchronization connection, bidirectional ( Factory setting: synchronized mode ) / Teach-In input
0 Level		≤ 3 V
1 Level		≥ 15 V
Input impedance		typ. 900 Ω
Number of sensors		max. 10
Switching output		
Output type		2 switch outputs PNP, NO ( NC contact programmable )
Default setting		300 ... 3500 mm ( adjustable via potentiometer )
Repeat accuracy	R	± 5 mm
Operating current	$I_L$	per 150 mA , short-circuit/overload protected
Switching frequency		≤ 2 Hz
Switching hysteresis		35 mm ( programmable )
Voltage drop		≤ 3 V
Off-state current		≤ 10 μA
Compliance with standards and directives		
Standard conformity		
Standards		EN IEC 60947-5-2:2020 IEC 60947-5-2:2019
Approvals and certificates		
UL approval		cULus Listed, Class 2 Power Source
CCC approval		CCC approval / marking not required for products rated ≤36 V
Ambient conditions		
Ambient temperature		-25 ... 70 °C (-13 ... 158 °F)
Storage temperature		-40 ... 85 °C (-40 ... 185 °F)
Shock resistance		30 g , 11 ms period
Vibration resistance		10 ... 55 Hz , Amplitude ± 1 mm
Mechanical specifications		
Connection type		Connector plug M12 x 1 , 5-pin
Housing diameter		30 mm
Degree of protection		IP65
Material		
Housing		brass, nickel-plated
Transducer		epoxy resin/hollow glass sphere mixture; polyurethane foam
Installation position		any position
Mass		170 g
Construction type		Cylindrical

Release date: 2023-02-16 Date of issue: 2023-02-16 Filename: 238381\_eng.pdf

Refer to "General Notes Relating to Pepperl+Fuchs Product Information".

Pepperl+Fuchs Group  
www.pepperl-fuchs.comUSA: +1 330 486 0001  
fa-info@us.pepperl-fuchs.comGermany: +49 621 776 1111  
fa-info@de.pepperl-fuchs.comSingapore: +65 6779 9091  
fa-info@sg.pepperl-fuchs.com

**PEPPERL+FUCHS**

**Connection**

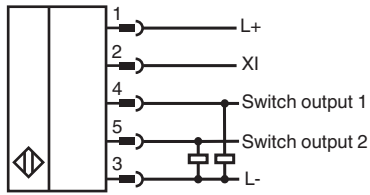

**Connection Assignment**

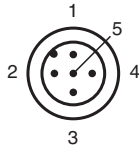

Wire colors in accordance with EN 60947-5-2

1	BN	(brown)
2	WH	(white)
3	BU	(blue)
4	BK	(black)
5	GY	(gray)

**Characteristic Curve**

**Characteristic response curve**

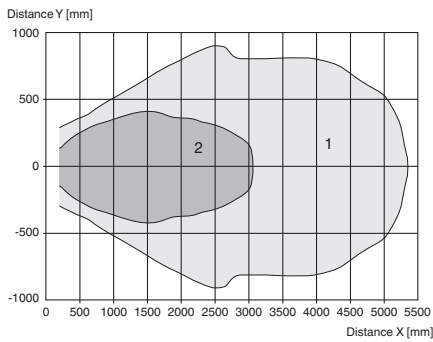

Curve 1: flat surface 100 mm x 100 mm  
Curve 2: round bar, Ø 25 mm



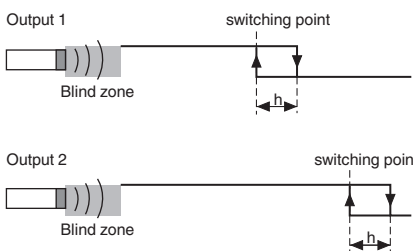

**Switching outputs operating mode**

Switching output mode



Release date: 2023-02-16 Date of issue: 2023-02-16 Filename: 238381\_eng.pdf

**Accessories**

	<b>BF 30</b>	Mounting flange, 30 mm
	<b>BF 5-30</b>	Universal mounting bracket for cylindrical sensors with a diameter of 5 ... 30 mm
	<b>V15-G-2M-PUR</b>	Female cordset single-ended M12 straight A-coded, 5-pin, PUR cable grey
	<b>ULTRA-PROG-IR</b>	Configuration software for ultrasonic sensors
	<b>UC-PROG-IR-USB</b>	Interface cable for parameterization of sensors with IrDA interface

Release date: 2023-02-16 Date of issue: 2023-02-16 Filename: 238381\_eng.pdf

Refer to "General Notes Relating to Pepperl+Fuchs Product Information".

Pepperl+Fuchs Group  
www.pepperl-fuchs.com

USA: +1 330 486 0001  
fa-info@us.pepperl-fuchs.com

Germany: +49 621 776 1111  
fa-info@de.pepperl-fuchs.com

Singapore: +65 6779 9091  
fa-info@sg.pepperl-fuchs.com

**Indication**

**Displays and Controls**

The sensor has two potentiometers and two display LEDs.

LED 1 (yellow)	<b>On/off:</b> Switching state of switching output 1 <b>Flashing:</b> Error when setting the switching points (switching point 2 < switching point 1). This state only occurs in window function operating mode (2 switching points).	
LED 2 (yellow)	<b>On/off:</b> Switching state of switching output 2 <b>Flashing:</b> Error when setting the switching points (switching point 2 < switching point 1). This state only occurs in window function operating mode (2 switching points).	
LED 2 (green)	<b>approx. 500 ms on:</b> Range limit taught in <b>Off:</b> Normal mode	
Potentiometer 1	Setting a switching point (Default setting: Setting the switching point of switching output 1)	
Potentiometer 2	Setting a switching point (Default setting: Setting the switching point of switching output 2)	

**Function**

**Setting the Sensor Using the Potentiometers**

The sensor is equipped with two potentiometers. These potentiometers are assigned to the two switching outputs by default. The switching outputs operate in switching point mode by default. Potentiometer P1 is used to set the switching point on switching output 1. Potentiometer P2 is used to set the switching point on switching output 2.

**Note:**

The function of the potentiometer can be altered using the ULTRA-PROG-IR software. As soon as a configuration has been changed, the potentiometer function selected using ULTRA-PROG-IR is activated.

**Parameterization**

**Parameterization via ULTRA-PROG-IR**

In order to be able to set the sensor parameters and adjust the sensor to the respective application, the sensor is able to communicate with a PC via the integrated infrared interface. The UC-18/30GM-IR interface cable is required to allow communication via this method. This cable is connected to an unused USB port on the PC.

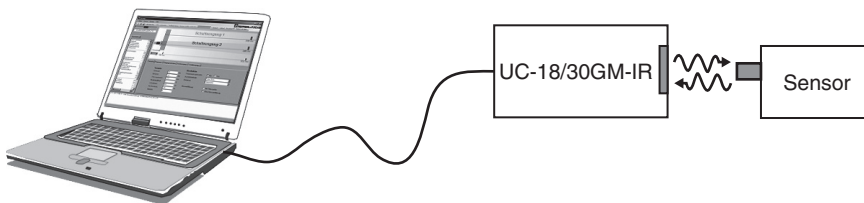

The ULTRA-PROG-IR parameterization software is also required for setting the sensor parameters. The ULTRA-PROG-IR software can be downloaded for free from the [www.pepperl-fuchs.com](http://www.pepperl-fuchs.com) website. The software allows all open parameters to be set, including:

- All trip points and switching hystereses
- Output modes and behaviors
- Delay times
- Settings and setting ranges of the potentiometer
- Settings for teach-in and synchronization
- Definition of blind zones
- Sensor modes and measurement methods
- Filtering measurement values

The following service functions are also available:

- Observing and recording measurement values
- Diagnosing interference reflections

**Teach-in**

The sensor is equipped with a function input (XI). In order to teach in a limit value, this sensor must be parameterized as the Teach-in input using the ULTRA-PROG-IR parameterization software. This parameterization software allows you to specify what limit value is taught in.

**Note:**

The Teach-in function is not activated when the sensor is delivered.

**Description of the Teach-in process:**

Release date: 2023-02-16 Date of issue: 2023-02-16 Filename: 238381\_eng.pdf

Refer to "General Notes Relating to Pepperl+Fuchs Product Information".

1. Position an object at the required distance.
2. Connect the Teach-in input to L-.  
The green LED lights up briefly after approx. 3 seconds. This indicates that the required distance has been successfully saved.
3. Disconnect the Teach-in input from L-.

**Note:**

If the Teach-in input remains connected to L-, the Teach-in process is repeated every 3 seconds.

## Commissioning

### Synchronization

The sensor features a function input (XI). Using the ULTRA-PROG-IR parameterization software, this function input can be configured as a synchronization input to suppress mutual interference from external ultrasonic signals. This is illustrated in the following description.

If the synchronization input is not connected, the sensor operates with internally generated cycle pulses.

### External synchronization

The sensor can be synchronized by applying external rectangular pulses. The pulse duration must be  $\geq 100 \mu\text{s}$ . Each rising pulse edge sends an individual ultrasonic pulse. If the signal at the synchronization input is high, the sensor reverts to the normal, unsynchronized operating mode.

If a low signal is applied to the synchronization input, the sensor switches to standby. In this operating mode, the last recorded output statuses are retained.

### Internal synchronization

#### Common mode operation

Up to ten sensors can be synchronized with each other. To do this, the synchronization inputs of the individual sensors are connected to each other. When configured in this state, all of the sensors send the ultrasonic signals together at the same time. The cycle rate corresponds to the cycle rate of the sensor with the lowest rate.

#### Multiplex mode

Up to ten sensors can work in multiplex mode; i.e. the sensors send their ultrasonic signals in succession. This prevents the sensor signals interfering with each other. In multiplex mode, the synchronization inputs of all sensors are connected to each other. An address must also be assigned to each sensor using the ULTRA-PROG-IR parameterization software, and the number of sensors to be synchronized must be determined. To start multiplex mode, all sensors are commissioned together by switching on the power supply.