

Thru-beam sensor

GA18-S/GK18-S/59/161/166

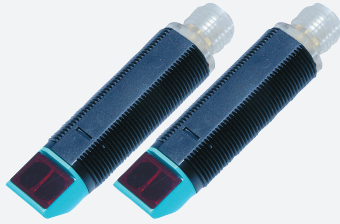

- Efficient Line in a short M18 plastic housing for standard applications
- Very high detection range
- 4 LEDs indicator for 360° visibility
- Sidelookerversion
- Universal usage at different power supplies

Thru-beam sensor, M18 threaded housing design, plastic housing, side optical face, 12 m detection range, red light, dark on, AC/DC version, NPN-FET output, micro plug



Function

The GLV/GLK18 series sensors help improve the efficiency of machines and systems. The design of the M18 plastic housing, the connection technology, and sensor properties are highly standardized. Concentrating on the key sensor requirements has produced a robust and reliable product series for DC and AC/DC voltage systems without any over-engineering. The mounting set included in the scope of delivery and the optimized potentiometer design ensure fast assembly and easy configuration.

Application

Packaging industry:

- Presence checks, track loading, completeness checks, stack height control

Material handling:

- Presence checks, target sensor, profile checks, trigger sensor

Automatic doors, gates and access systems, elevator:

- Secure detection for automatic door and gate systems
- Monitoring function in turnstiles
- Closing edge monitoring in elevators

Dimensions

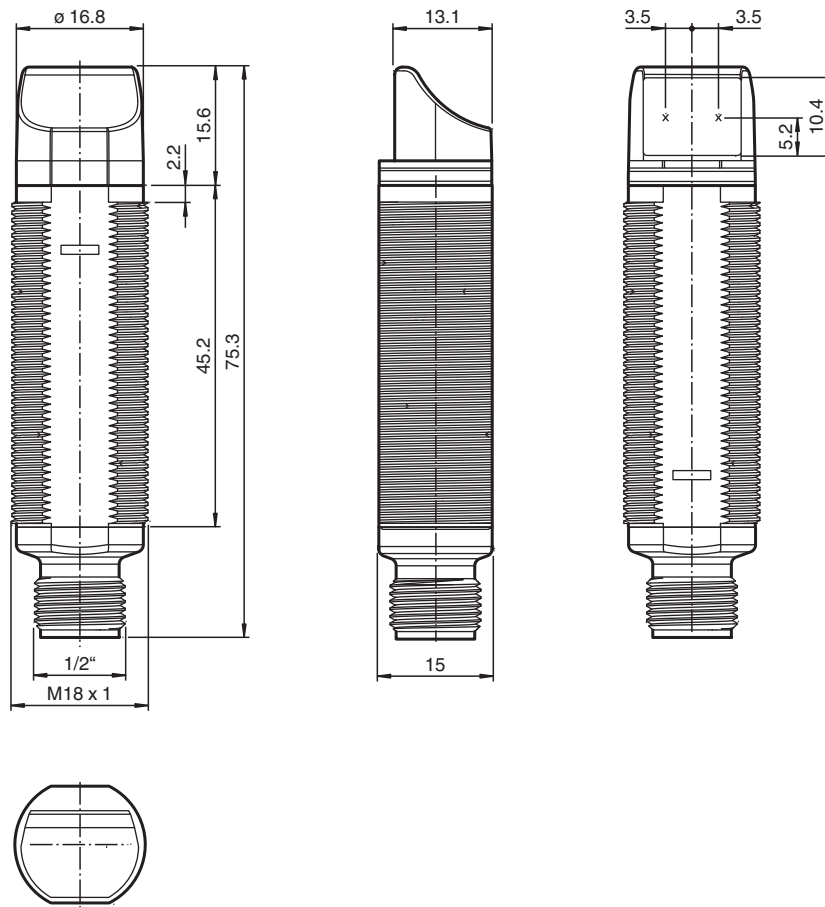

Technical Data

System components		
Emitter		GA18-S/166
Receiver		GK18-S/59/161/166
General specifications		
Effective detection range		0 ... 12 m
Threshold detection range		17.5 m
Light source		LED
Light type		modulated visible red light , 640 nm
Diameter of the light spot		approx. 650 mm at 17.5 m
Opening angle		approx. 2 °
Optical face		lateral
Ambient light limit		30000 Lux
Accessories provided		Mounting aids
Indicators/operating means		
Operation indicator		LED green, statically lit Power on
Function indicator		Receiver: LED yellow, lights up when light beam is free, flashes when falling short of the operating reserve ; OFF when light beam is interrupted
Electrical specifications		
Operating voltage	U _B	20 ... 250 V AC/DC
No-load supply current	I ₀	< 2.5 mA per device
Output		
Switching type		dark-on

Release date: 2022-11-18 Date of issue: 2022-11-18 Filename: 199786_eng.pdf

Technical Data

Signal output	N-channel MOSFET, short circuit protected	
Switching voltage		max. 250 V AC/DC
Switching current		max. 200 mA
Voltage drop	U_d	≤ 3.5 V AC/DC
Switching frequency	f	50 Hz
Response time		≤ 10 ms
Conformity		
Product standard		EN 60947-5-2
Compliance with standards and directives		
Standard conformity		
Standards		UL 508
Approvals and certificates		
Protection class		II, rated insulation voltage ≤ 250 V AC with pollution degree 1-2 according to IEC 60664-1
UL approval		cULus Listed, Type 1 enclosure
CCC approval		Certified by China Compulsory Certification (CCC)
Ambient conditions		
Ambient temperature		-20 ... 60 °C (-4 ... 140 °F)
Storage temperature		-40 ... 70 °C (-40 ... 158 °F)
Mechanical specifications		
Degree of protection		IP67
Connection		Micro AC connector, 1/2" V124 ; 4-pin
Material		
Housing		ABS / PBT
Optical face		PMMA
Mass		approx. 10 g per device

Connection Assignment

Transmitter

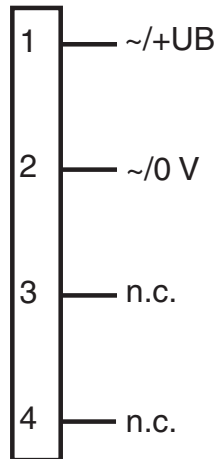

Receiver

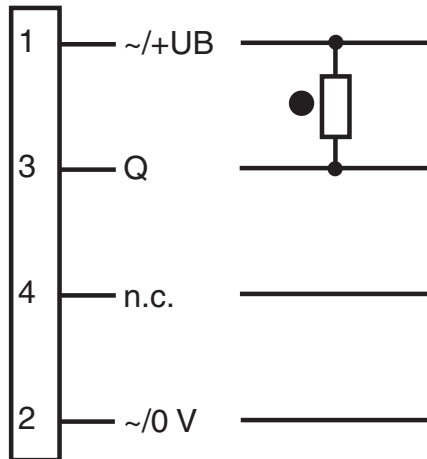

○ = Light on
● = Dark on

Connection Assignment

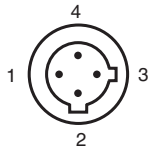

Assembly

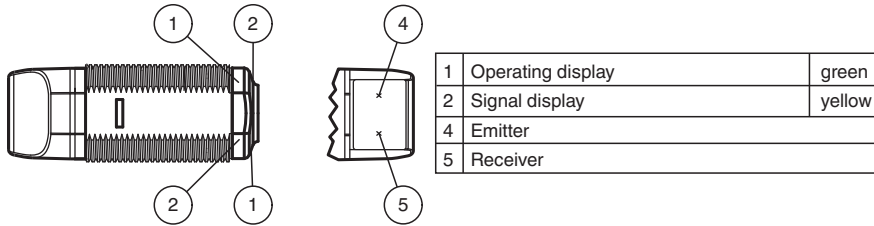

Characteristic Curve

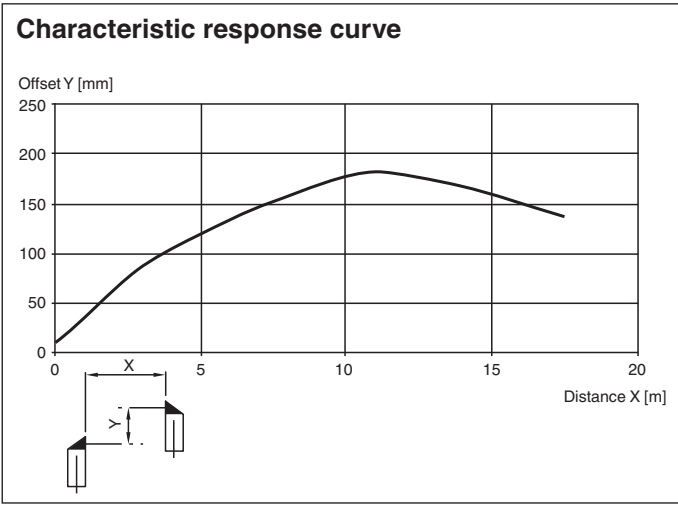

Release date: 2022-11-18 Date of issue: 2022-11-18 Filename: 199786_eng.pdf

Refer to "General Notes Relating to Pepperl+Fuchs Product Information".

Characteristic Curve

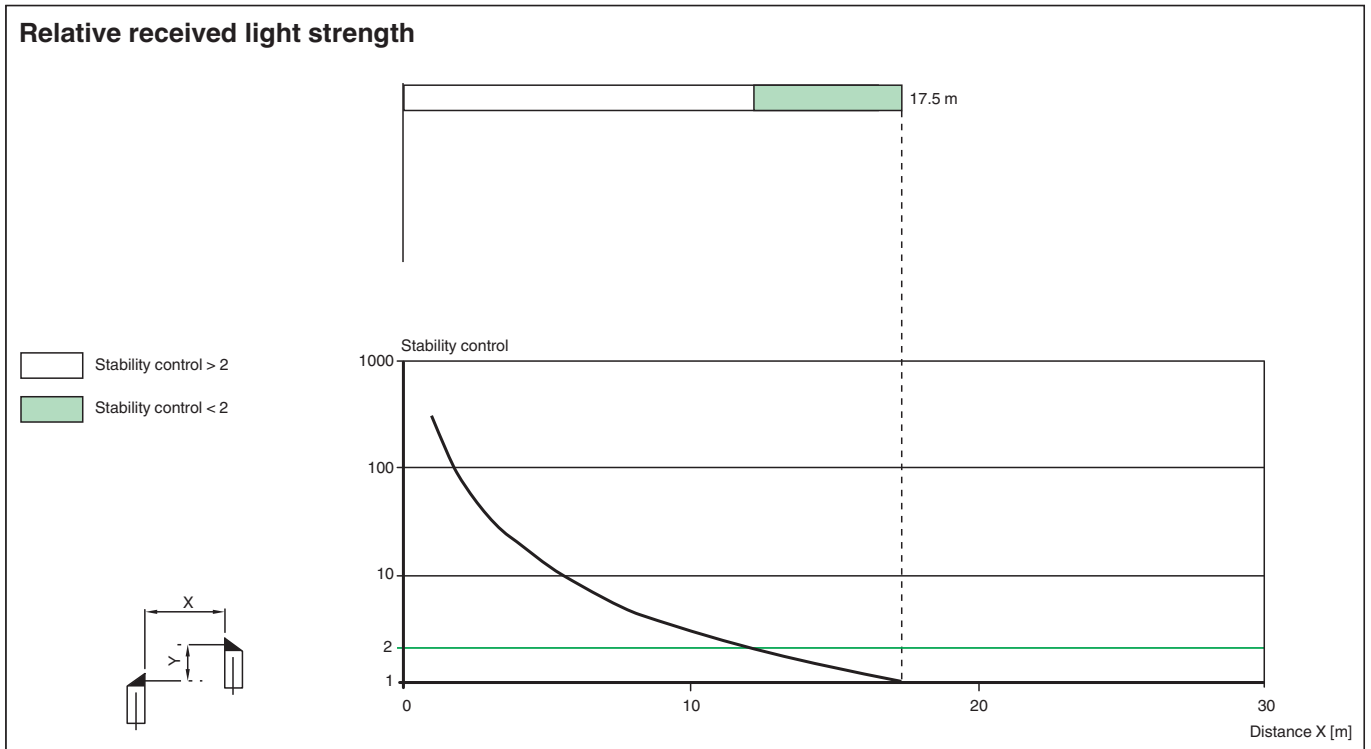

Accessories

	CPZ18B03	Mounting Bracket with swivel nut
	BF 18	Mounting flange, 18 mm
	BF 18-F	Plastic mounting adapter, 18 mm
	BF 5-30	Universal mounting bracket for cylindrical sensors with a diameter of 5 ... 30 mm
	V124-G-YE2M-PVC	Connecting cable, 1/2" - 20 UNF, 4-pin, PVC cable
	V124-W-YE2M-PVC	Connecting cable, 1/2" - 20 UNF, 4-pin, PVC cable

Release date: 2022-11-18 Date of issue: 2022-11-18 Filename: 199786_eng.pdf