

# Connection cable

## V15-W-VT5M-PUR-U/CAN-V15-G



- Suitable for DeviceNet and CANopen
- Suitable for drag chains and abrasion resistant
- Degree of protection IP68 / IP69
- Resistant to microbes and hydrolysis
- Resistant to salt water
- UL listed for USA and Canada
- Halogen-free
- Specific design protects against loosening and inaccurate installation

DeviceNet/CANOpen bus cable M12 socket angled to M12 plug straight A-coded, 5-pin, PUR cable violet, shielded, UL approved, drag chain suitable, salt water resistant



### Dimensions

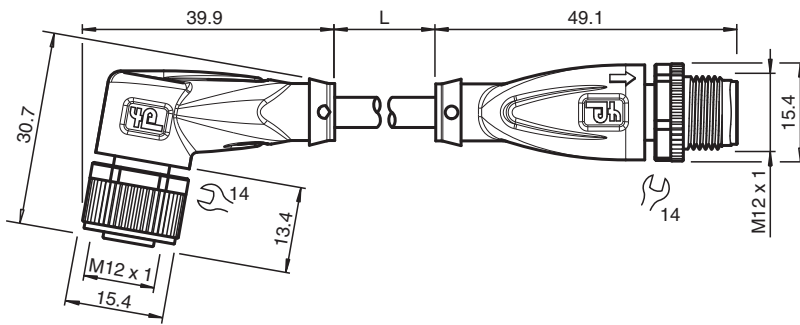

### Technical Data

#### General specifications

<b>Connector 1</b>		
Connection		socket
Construction type		M12
Style		angled
Locking		screw connection
Number of pins		5
Coding		A-coded
<b>Connector 2</b>		
Connection		plug
Construction type		M12
Style		straight
Locking		screw connection
Number of pins		5
Coding		A-coded
<b>Electrical specifications</b>		
Operating voltage	$U_B$	max. 48 V AC / 60 V DC
Operating current	$I_B$	max. 4 A
Characteristic impedance		120 $\Omega$ $\pm$ 12 $\Omega$ (1 MHz)
<b>Conformity</b>		
Degree of protection		EN 60529

Release date: 2023-07-05 Date of issue: 2023-07-05 Filename: 70137145\_eng.pdf

Refer to "General Notes Relating to Pepperl+Fuchs Product Information".

Pepperl+Fuchs Group  
www.pepperl-fuchs.com

USA: +1 330 486 0001  
fa-info@us.pepperl-fuchs.com

Germany: +49 621 776 1111  
fa-info@de.pepperl-fuchs.com

Singapore: +65 6779 9091  
fa-info@sg.pepperl-fuchs.com

**PF** PEPPERL+FUCHS

## Technical Data

Plug connection		connector M12 x 1 : IEC 61076-2-101
Flammability		UL 2556 , IEC 60332-1-2
Halogen-free		IEC 60754-1
Chemical resistance		DIN EN 60811-2-1
Oil resistance		DIN EN 60811-2-1
<b>Approvals and certificates</b>		
UL approval		CMX listed (cable)
UL File Number		E231213
<b>Ambient conditions</b>		
Ambient temperature		
Plug connector		-25 ... 90 °C (-13 ... 194 °F)
Cable, fixed		-20 ... 80 °C (-4 ... 176 °F)
Cable, flexing		-20 ... 80 °C (-4 ... 176 °F)
Pollution degree		3
<b>Mechanical specifications</b>		
Plug connector		
Tightening torque		0.6 Nm
Loosening protection		available
Tool installation		straight knurling and hexagon nut SW = 14 mm
Mating cycles		min. 100
Shielding		shield connected to pin 1 and screw connection
Degree of protection		IP68 / IP69
Cable		according to IEC/EN 60228 (DIN VDE 0295) class 5
Sheath diameter		6.1 mm
Bending radius		> 8 x cable diameter, moving > 4 x cable diameter, fixed
Sheath stripping force		max. 60 N / 100 mm
Sheath color		violet (similar to RAL 4001)
Number of cores		4
Core cross section		0.34 mm <sup>2</sup>
Cores color		Core 1: red Core 2: black Core 3: white Core 4: blue
Core construction		7 x 0.254 mm Ø twisted quad
Shield		tinned copper braiding, 80 % coverage
Length	L	5 m
Cable code		Li 9Y 11Y 4 x 0.34
Drag chain suitability		
Drag chain cycles		min. 3000000
Motion velocity		max. 2.5 m/s
Acceleration		max. 12 m/s <sup>2</sup>
<b>Material</b>		
Halogen-free		yes
Plug connector		
Screw connection		Zinc diecast, nickel-plated
Body		TPU, black
Seal		FKM
Contact surface		gold plated (Au)
Flammability		V-2
Cable		
Sheathing		PUR based on polyether
Core insulation		PP
Salt water resistance		yes

Release date: 2023-07-05 Date of issue: 2023-07-05 Filename: 70137145\_eng.pdf

Refer to "General Notes Relating to Pepperl+Fuchs Product Information".

 Pepperl+Fuchs Group  
www.pepperl-fuchs.com

 USA: +1 330 486 0001  
fa-info@us.pepperl-fuchs.com

 Germany: +49 621 776 1111  
fa-info@de.pepperl-fuchs.com

 Singapore: +65 6779 9091  
fa-info@sg.pepperl-fuchs.com

 **PEPPERL+FUCHS**





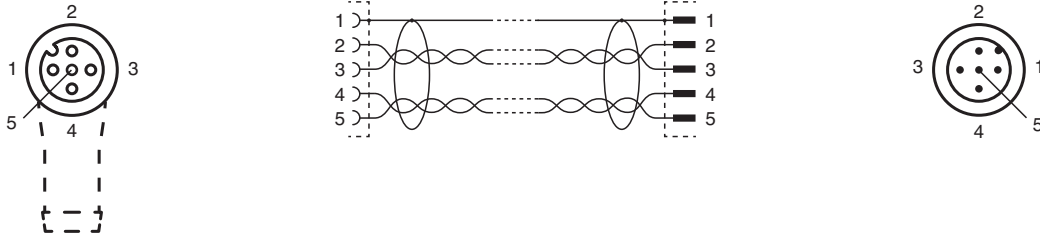

### Technical Data

Oil resistance	yes
Microbial resistance	yes
Hydrolysis resistance	yes
Flammability	VW-1

### Connection



### Accessories

	<b>MH V1-SCREWDRIVER</b>	Torque screwdriver (0.6 Nm)
	<b>MH V1-BIT M12</b>	plug-in cap M12
	<b>V1/V3-LABELHOLDER</b>	Label holder
	<b>V1/V3-LABEL</b>	Label plate
	<b>MH V1-Holder</b>	Modular universal holder for M12 connectors
	<b>V1-CLIP</b>	Unlocking protector for M12 connector
	<b>V1-MARKING-RING-COLOR</b>	Marking rings for M12 connectors, various colors

Release date: 2023-07-05 Date of issue: 2023-07-05 Filename: 70137145\_eng.pdf