

Valve Connector Cordset VMCI-2+P/Z2-2M-PVC

- Z diode as a protective circuit
- Built-in LED, as operating and function indicator
- Moulded seal
- freely selectable cable models due to bridged protective earth
- Flame resistant cable
- Oil resistant

Valve connector Form C (Ind), Z-diode LED 2-pin+PE, PVC cable black



Dimensions

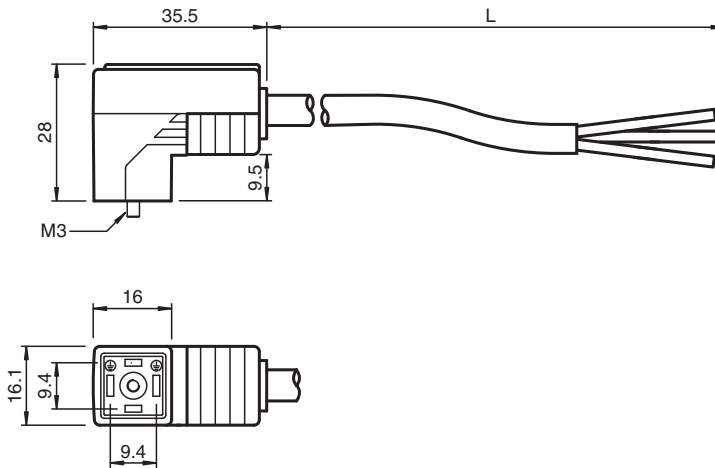

Technical Data

General specifications			
Connector 1			
Connection			Valve connector industrial version
Construction type			form C
Style			angled
Locking			screw connection
Number of pins			2 + PE
Connector 2			
Connection			cable end
Indicators/operating means			
LED yellow			Operating display
Electrical specifications			
Operating voltage	U_B		24 V AC/DC
Operating current	I_B		max. 4 A
Suppression			Zener diode
Conformity			
Degree of protection			EN 60529

Release date: 2023-09-04 Date of issue: 2023-09-04 Filename: 246192_eng.pdf

Refer to "General Notes Relating to Pepperl+Fuchs Product Information".

Pepperl+Fuchs Group
www.pepperl-fuchs.com

USA: +1 330 486 0001
fa-info@us.pepperl-fuchs.com

Germany: +49 621 776 1111
fa-info@de.pepperl-fuchs.com

Singapore: +65 6779 9091
fa-info@sg.pepperl-fuchs.com

 PEPPERL+FUCHS

Technical Data

Plug connection	Valve connector : DIN EN 175301-803	
Flammability	DIN VDE 0482 , DIN EN 50265-2-1	
Ambient conditions		
Ambient temperature		
Plug connector	-20 ... 85 °C (-4 ... 185 °F)	
Cable, fixed	-40 ... 80 °C (-40 ... 176 °F)	
Cable, flexing	-5 ... 80 °C (23 ... 176 °F)	
Pollution degree	3	
Mechanical specifications		
Plug connector		
Tightening torque	0.6 Nm	
Tool installation	screw M3 x 29	
Mating cycles	min. 100	
Degree of protection	IP65/IP67	
Cable	according to IEC/EN 60228 (DIN VDE 0295) class 5	
Sheath diameter	4.8 mm	
Bending radius	> 5 x cable diameter, fixed	
Sheath color	black (similar to RAL 9005)	
Number of cores	3	
Core cross section	0.5 mm ²	
Cores color	Core 1: black 1 Core 2: black 2 Core 3: green/yellow	
Core construction	16 x 0.2 mm Ø	
Length	L	2 m
Cable code	Li YY 3 x 0,50	
Material		
Plug connector		
Body	TPU, black	
Seal	TPU , molded	
Contact surface	Sn	
Flammability	V-0	
Cable		
Sheathing	PVC	
Core insulation	PVC	
Oil resistance	good	
Flammability	V-0	

Connection

