



Triangulation sensor (BGS)

OBT20-R2-E0-P



- High-performance miniature photoelectric sensors
- 45° cable outlet for maximum mounting freedom under extremely tight space constraints
- Extremely small light spot for very high switching point accuracy
- Highly visible light spot, even on dark materials
- Precision detection of objects within the defined sensing range, almost irrespective of the color

Triangulation sensor with background suppression for standard applications, miniature design, 20 mm detection range, red light, light on, NPN output, 2 m fixed cable



Function

The nano sensor has been developed for a broad range of applications. It offers excellent durability and is exceptionally easy to install. The housing is compact and, with its 45° cable outlet, can be installed in the smallest spaces. New functional principles and functionality open up a range of new options.

Dimensions

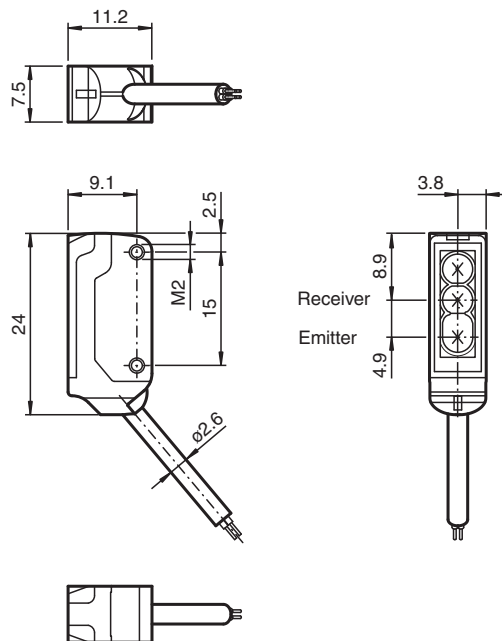

Technical Data

General specifications	
Detection range	4 ... 20 mm
Reference target	standard black, 100 mm x 100 mm
Light source	LED
Light type	modulated visible red light , 630 nm

Release date: 2023-04-05 Date of issue: 2023-04-05 Filename: 70141935_eng.pdf

Refer to "General Notes Relating to Pepperl+Fuchs Product Information".

Pepperl+Fuchs Group
www.pepperl-fuchs.com

USA: +1 330 486 0001
fa-info@us.pepperl-fuchs.com

Germany: +49 621 776 1111
fa-info@de.pepperl-fuchs.com

Singapore: +65 6779 9091
fa-info@sg.pepperl-fuchs.com

PF PEPPERL+FUCHS

Technical Data

Black-white difference (6 %/90 %)		< 5 % at 20 mm
Angle deviation		approx. 2 °
Diameter of the light spot		approx. 2 mm at a distance of 20 mm
Opening angle		approx. 2 °
Optical face		frontal
Ambient light limit		EN 60947-5-2 : 30000 Lux
Functional safety related parameters		
MTTF _d		800 a
Mission Time (T _M)		20 a
Diagnostic Coverage (DC)		0 %
Indicators/operating means		
Operation indicator		LED green, statically lit Power on , short-circuit : LED green flashing (approx. 4 Hz)
Function indicator		LED yellow ON: lights when object is detected
Electrical specifications		
Operating voltage	U _B	10 ... 30 V DC , class 2
No-load supply current	I ₀	< 10 mA
Protection class		III
Output		
Switching type		NO contact / light on
Signal output		1 NPN output, short-circuit protected, reverse polarity protected, open collector
Switching voltage		max. 30 V DC
Switching current		max. 50 mA , resistive load
Voltage drop	U _d	≤ 1.5 V DC
Switching frequency	f	approx. 800 Hz
Response time		600 μs
Conformity		
Product standard		EN 60947-5-2
Approvals and certificates		
UL approval		E87056 , cULus Recognized, Class 2 Power Source
CCC approval		CCC approval / marking not required for products rated ≤36 V
Ambient conditions		
Ambient temperature		-25 ... 60 °C (-13 ... 140 °F)
Storage temperature		-30 ... 70 °C (-22 ... 158 °F)
Mechanical specifications		
Housing width		7.5 mm
Housing height		24 mm
Housing depth		11.2 mm
Degree of protection		IP67
Connection		2 m fixed cable
Material		
Housing		PC/ABS and TPU
Optical face		PC
Cable		PUR
Installation		Fixing screws , 2 x M2 allen head screws included with delivery
Mass		approx. 20 g
Cable length		2 m

Release date: 2023-04-05 Date of issue: 2023-04-05 Filename: 70141935_eng.pdf

Refer to "General Notes Relating to Pepperl+Fuchs Product Information".

Pepperl+Fuchs Group
www.pepperl-fuchs.comUSA: +1 330 486 0001
fa-info@us.pepperl-fuchs.comGermany: +49 621 776 1111
fa-info@de.pepperl-fuchs.comSingapore: +65 6779 9091
fa-info@sg.pepperl-fuchs.com

PEPPERL+FUCHS

Connection



Assembly





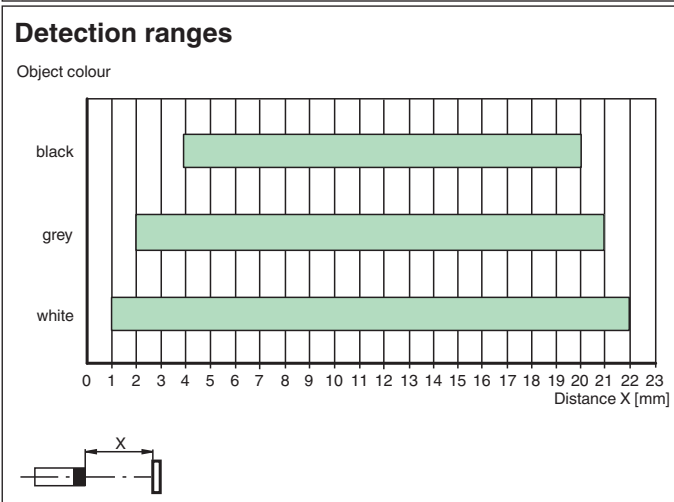
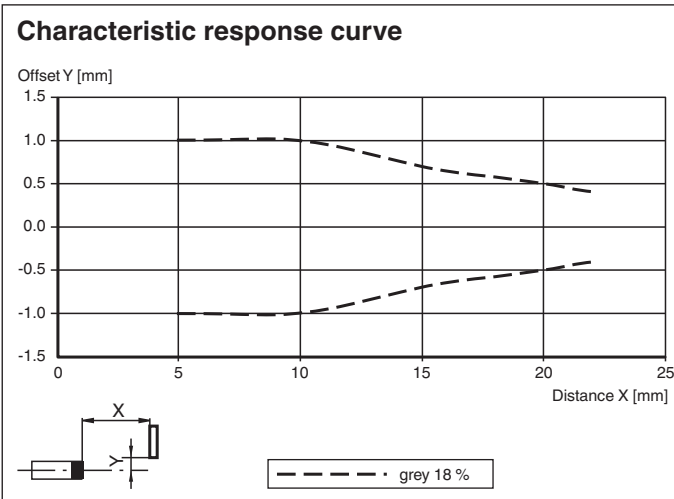

1	Operating display	green
2	Signal display	yellow
3	Emitter	
4	Receiver	

Characteristic Curve



Release date: 2023-04-05 Date of issue: 2023-04-05 Filename: 70141935_eng.pdf

Accessories

	MH-R2-01	Mounting aid for R2 series, Mounting bracket
	MH-R2-02	Mounting aid for R2 series, Mounting bracket
	MH-R2-03	Mounting aid for R2 series, Mounting bracket
	MH-R2-04	Mounting aid for R2 series, Mounting bracket

Release date: 2023-04-05 Date of issue: 2023-04-05 Filename: 70141935_eng.pdf

Refer to "General Notes Relating to Pepperl+Fuchs Product Information".

Pepperl+Fuchs Group
www.pepperl-fuchs.com

USA: +1 330 486 0001
fa-info@us.pepperl-fuchs.com

Germany: +49 621 776 1111
fa-info@de.pepperl-fuchs.com

Singapore: +65 6779 9091
fa-info@sg.pepperl-fuchs.com