



Vision Sensor

PHA250-F200A-R2-T-6640



- Large capture range
- High operating range
- Integrated contrast compensation
- Compact design
- Integrated illumination
- Detects the position of an index hole

Precision positioning on hole in the 70 mm x 70 mm housing



Function

The sensor has been developed for the precision positioning of high-bay racking operating equipment. It detects circular holes in the racking structure and their positional deviation from the nominal position. The sensor operates in two dimensions.

Dimensions

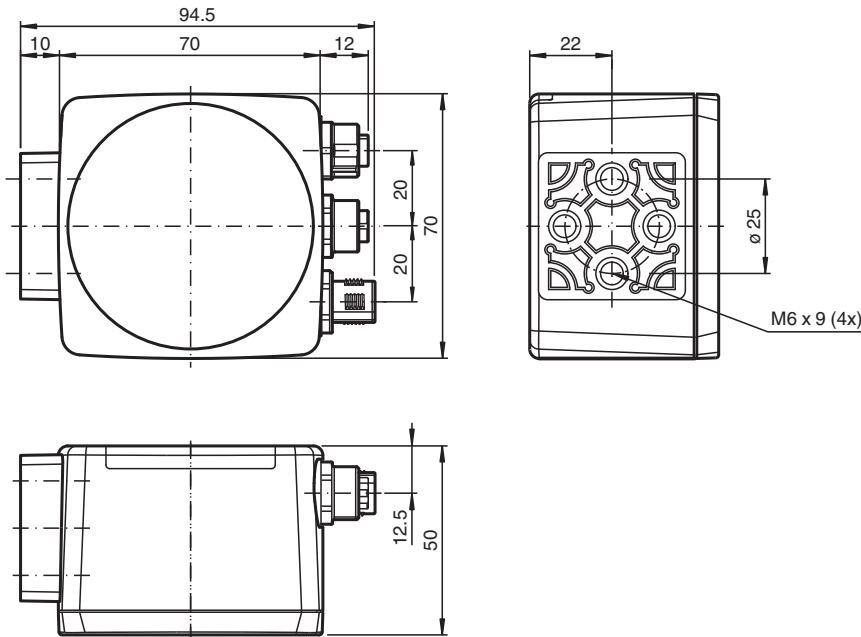

Release date: 2022-08-09 Date of issue: 2022-08-09 Filename: 273661_eng.pdf

Technical Data

General specifications

Light source	LED
Light type	Integrated LED lightning (infrared)
Object size	Hole diameter 13 mm
Response delay	100 ms
Read distance	250 mm

Refer to "General Notes Relating to Pepperl+Fuchs Product Information".

Pepperl+Fuchs Group
www.pepperl-fuchs.com

USA: +1 330 486 0001
fa-info@us.pepperl-fuchs.com

Germany: +49 621 776 1111
fa-info@de.pepperl-fuchs.com

Singapore: +65 6779 9091
fa-info@sg.pepperl-fuchs.com

pepperl+fuchs

Technical Data

Depth of focus		± 50 mm
Capture range		max. 120 mm x 100 mm
Nominal ratings		
Camera		
Type		CMOS , Global shutter
Number of pixels		752 x 480 pixels
Gray scale		256
Functional safety related parameters		
MTTF _d		65 a
Mission Time (T _M)		10 a
Diagnostic Coverage (DC)		0 %
Indicators/operating means		
Operation indicator		LED green: Ready for operation
Function indicator		4 x LED yellow: +X, -X, +Y, -Y
Control elements		none
Electrical specifications		
Operating voltage	U _B	24 V DC ± 15% , PELV
No-load supply current	I ₀	max. 250 mA
Power consumption	P ₀	6 W
Interface		
Interface type		serial , RS 232
Transfer rate		max. 115.2 kBit/s
Cable length		max. 30 m
Interface 1		
Interface type		Ethernet
Protocol		TCP/IP
Transfer rate		100 MBit/s
Cable length		max. 30 m
Input		
Input voltage		to be applied externally 24 V ± 15% PELV
Number/Type		Cycle stop, relative stroke
Input current		1.6 mA at 24 V
Switching threshold		low: < 10 V, high: > 15 V
Cable length		max. 30 m
Output		
Switching type		PNP , short-circuit/overload protected
Signal output		+X, -X, +Y, -Y
Switching voltage		24 V
Switching current		max. 100 mA each output
Cable length		max. 30 m
Conformity		
Shock resistance		EN 60068-2-27:2009
Vibration resistance		EN 60068-2-6:2008
Emitted interference		EN 61000-6-4:2007+A1:2011
Noise immunity		EN 61326-1:2013
Photobiological safety		exempt group according EN 62471:2008
Approvals and certificates		
CE conformity		CE
UL approval		cULus Listed, General Purpose, Class 2 Power Source, Type 1 enclosure
CCC approval		CCC approval / marking not required for products rated ≤36 V
Ambient conditions		
Operating temperature		0 ... 60 °C (32 ... 140 °F) , -30 ... 60 °C (-22 ... 140 °F) (noncondensing; prevent icing on the lens!)

Release date: 2022-08-09 Date of issue: 2022-08-09 Filename: 273661_eng.pdf

Refer to "General Notes Relating to Pepperl+Fuchs Product Information".

Pepperl+Fuchs Group
www.pepperl-fuchs.com

USA: +1 330 486 0001
fa-info@us.pepperl-fuchs.com

Germany: +49 621 776 1111
fa-info@de.pepperl-fuchs.com

Singapore: +65 6779 9091
fa-info@sg.pepperl-fuchs.com

 PEPPERL+FUCHS

Technical Data

Storage temperature	-30 ... 85 °C (-22 ... 185 °F)
Relative humidity	90 % , noncondensing
Shock resistance	< 50 g
Vibration resistance	< 3 G , 11 ... 200 Hz
Mechanical specifications	
Housing width	70 mm
Housing height	70 mm
Housing depth	50 mm
Degree of protection	IP67
Connection	8-pin, M12x1 connector, standard (supply+IO) , 5-pin, M12x1 socket, standard (RS 232) , 4-pin, M12x1 socket, standard (LAN)
Material	
Housing	PC/ABS
Optical face	Plastic pane
Installation	4 x M6 threading
Mass	approx. 160 g

Connection

RS 232



Pin	Signal
1	+UB
2	TX RS232
3	GND
4	RX RS232
5	NC

LAN

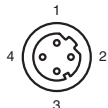

Pin	Signal
1	TX+ Ethernet
2	RX+ Ethernet
3	TX- Ethernet
4	RX- Ethernet

24 V DC+IO

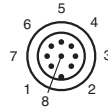

Pin	Signal
1	OUT +X
2	+UB
3	OUT -Y
4	OUT +Y
5	OUT -X
6	IN 1
7	GND
8	IN 2

Release date: 2022-08-09 Date of issue: 2022-08-09 Filename: 273661_eng.pdf



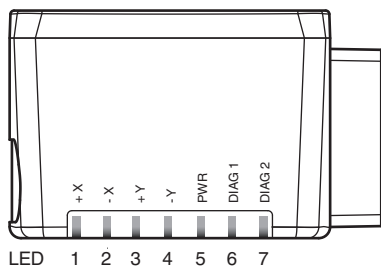
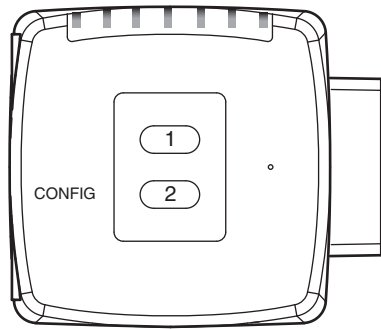

Assembly

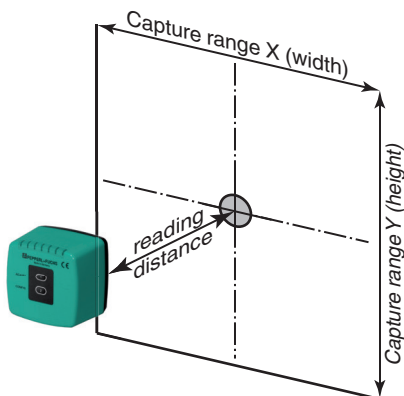

Characteristic Curve



Accessories

	V19-G-BK5M-PUR-U/ABG	Female cordset single-ended M12 straight A-coded, 8-pin, PUR cable black, shielded, UL approved
	CBL-PUR-ABG-GY-04x034-100M	Cable, PUR/PP, 4-core grey, shielded
	V45-G	Male connector RJ45 straight 4-pin, Cat5, shielded, field-attachable
	PCV-MB1	Mounting bracket for PCV* read head

Release date: 2022-08-09 Date of issue: 2022-08-09 Filename: 273661_eng.pdf

Refer to "General Notes Relating to Pepperl+Fuchs Product Information".

Pepperl+Fuchs Group
www.pepperl-fuchs.com

USA: +1 330 486 0001
fa-info@us.pepperl-fuchs.com

Germany: +49 621 776 1111
fa-info@de.pepperl-fuchs.com

Singapore: +65 6779 9091
fa-info@sg.pepperl-fuchs.com