



Optical reading head PGV100-F200A-B25-V1D

- Mechanically rugged: no wearing parts, long operating life, maintenance-free
- EtherNet/IP interface
- Non-contact positioning on Data Matrix code tape
- Noncontact positioning with Data Matrix TAGs
- Noncontact lane tracking of a colored strip
- Reading of Data Matrix control codes
- White-blue light

Read head for incident light positioning system



Dimensions

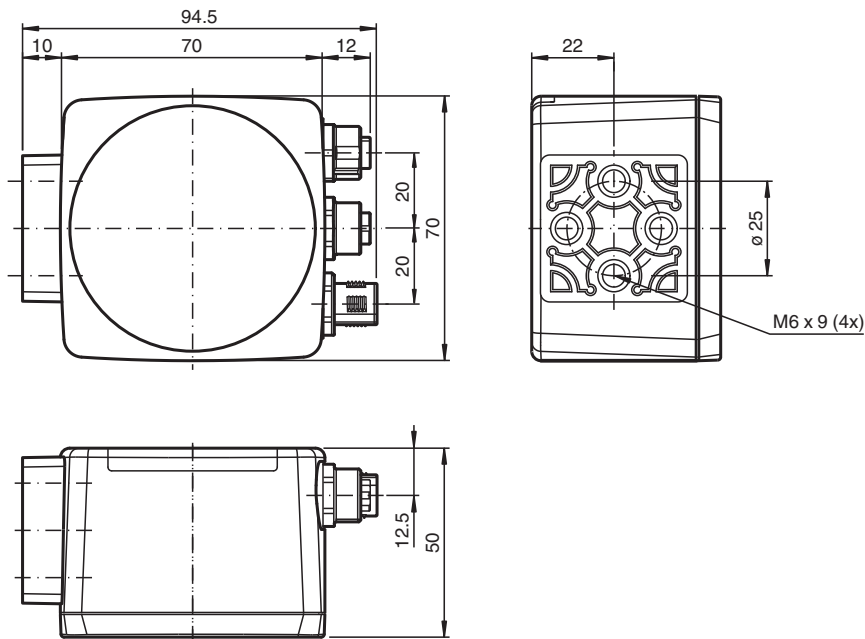

Technical Data

General specifications

Passage speed	v	≤ 8 m/s
Measuring range		max. 10000 m
Light type		Integrated LED lightning (white/blue)
Scan rate		25 s ⁻¹
Latency		60 ms
Read distance		100 mm
Depth of focus		± 20 mm
Reading field		120 mm x 80 mm
Ambient light limit		100000 Lux

Release date: 2023-02-24 Date of issue: 2023-02-24 Filename: 285693-100006_eng.pdf

Refer to "General Notes Relating to Pepperl+Fuchs Product Information".

Pepperl+Fuchs Group
www.pepperl-fuchs.com

USA: +1 330 486 0001
fa-info@us.pepperl-fuchs.com

Germany: +49 621 776 1111
fa-info@de.pepperl-fuchs.com

Singapore: +65 6779 9091
fa-info@sg.pepperl-fuchs.com

PEPPERL+FUCHS

Technical Data

Accuracy		± 0.2 mm
Nominal ratings		
Camera		
Type		CMOS , Global shutter
Processor		
Clock pulse frequency		600 MHz
Speed of computation		4800 MIPS
Functional safety related parameters		
MTTF _d		88 a
Mission Time (T _M)		10 a
Diagnostic Coverage (DC)		0 %
Indicators/operating means		
LED indication		7 LEDs (communication, alignment aid, status information)
Electrical specifications		
Operating voltage	U _B	15 ... 30 V DC , PELV
No-load supply current	I ₀	max. 400 mA
Power consumption	P ₀	6 W
Interface		
Interface type		100 BASE-TX
Protocol		EtherNet/IP
Transfer rate		100 MBit/s
Interface 2		
Interface type		USB Service
Input		
Input type		1 function input 0-level: -U _B or unwired 1-level: +8 V ... +U _B , programmable
Input impedance		≥ 27 kΩ
Output		
Output type		1 to 3 switch outputs , PNP , programmable , short-circuit protected
Switching voltage		Operating voltage
Switching current		150 mA each output
Conformity		
Shock resistance		EN 60068-2-27:2009
Vibration resistance		EN 60068-2-6:2008
Emitted interference		EN 61000-6-4:2007+A1:2011
Noise immunity		EN 61000-6-2:2005
Photobiological safety		Risk group 1 according to EN 62471:2008
Approvals and certificates		
CE conformity		CE
UL approval		cULus Listed, General Purpose, Class 2 Power Source, Type 1 enclosure
CCC approval		CCC approval / marking not required for products rated ≤36 V
Ambient conditions		
Operating temperature		0 ... 60 °C (32 ... 140 °F) , -20 ... 60 °C (-4 ... 140 °F) (noncondensing; prevent icing on the lens!)
Storage temperature		-20 ... 85 °C (-4 ... 185 °F)
Relative humidity		90 % , noncondensing
Mechanical specifications		
Connection type		8-pin, M12x1 connector, standard (supply+IO) 4-pin, M12x1 socket, D-coded (LAN) 4-pin, M12x1 socket, D-coded (LAN)
Housing width		70 mm
Housing height		70 mm
Housing depth		50 mm
Degree of protection		IP67

Release date: 2023-02-24 Date of issue: 2023-02-24 Filename: 285693-100006_eng.pdf

Technical Data

Material		
Housing		PC/ABS
Mass		approx. 200 g
Factory settings		
X resolution (protocol)		1 mm
Y resolution (protocol)		1 mm
Angle resolution		1 °
Extrapolation		On

Connection

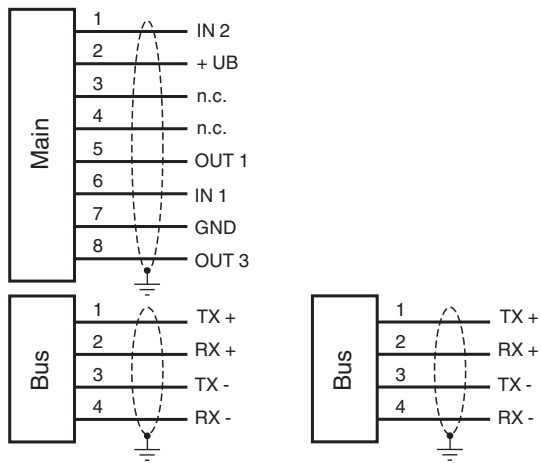

Connection Assignment

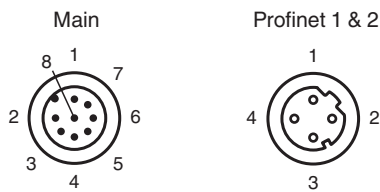



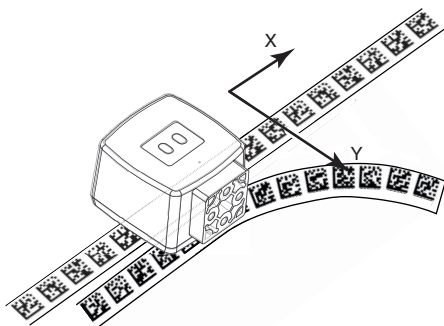



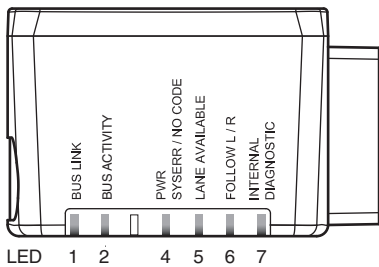
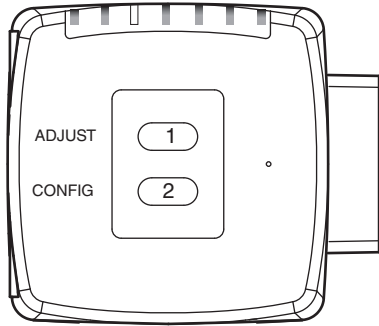

Function Principle



Function Principle



Matching System Components











	PGV*-CA25-*	Data Matrix code tape
	PGV*-CC25-*	Control code tape für PGV System
	PGV85-CT4	Data Matrix tag for PGV system
	PGV25M-CD100-CLEAR	Protective laminate for PGV code tape
	PGV25M-CD160-CLEAR	Protective laminate for PGV code tape
	PGV33M-CB19-BU	PGV color-tape blue
	PGV33M-CB19-GN	PGV color-tape green
	PGV33M-CB19-RD	PGV color-tape red
	PGV33M-CB19-YE	PGV color-tape yellow

Accessories

	V19-G-ABG-PG9	Female connector M12 straight A-coded 8-pin, for cable diameter 5 - 8 mm, shielded, field-attachable
---	----------------------	--

Release date: 2023-02-24 Date of issue: 2023-02-24 Filename: 285693-100006_eng.pdf

Accessories

	V19-G-ABG-PG9-FE	Female connector, M12, 8-pin, shielded, field attachable
	V19-G-2M-PUR-ABG	Female cordset single-ended M12 straight A-coded, 8-pin, PUR cable grey, shielded
	V19-G-5M-PUR-ABG	Female cordset single-ended M12 straight A-coded, 8-pin, PUR cable grey, shielded
	PCV-SC12	Grounding clip for PCV system
	PCV-AG100	Alignment guide for PCV100-* read head
	PCV-LM25	Marker head for 25 mm code tape
	PCV-MB1	Mounting bracket for PCV* read head
	Vision Configurator	Operating software for camera-based sensors
	PCV-KBL-V19-STR-USB	USB cable unit with power supply
	PGV25M-CD120-CLEAR	Protective laminate for PGV code tape
	VAZ-V1S-B	Blind plug for M12 sockets

Additional Information

General

The PGV... reader forms part of the positioning system in the Pepperl+Fuchs incident light process. The reader's features include a camera module and an integrated illumination unit. The reader uses these features to detect a colored strip stuck to the floor to track the lane. The reader also detects control codes and position markers in the form of Data Matrix codes attached to a self-adhesive code tape. The code tape is usually mounted in a fixed position instead of the colored strip or parallel to the colored strip. The reader is located on the front of an automated guided vehicle and guides this vehicle along the colored strip.

Mounting and Commissioning

Mount the reader such that the optical surface of the device captures the optimum reading distance to the colored strip (see "Technical Data"). The stability of the mounting and the manner in which the vehicle is guided ensure that the reader is not operated outside of its depth of focus range. The colored strip must not leave the maximum reading window for the reader during this process.

All readers can be adapted to optimally meet specific requirements by means of parameterization.

Indicators and Operating Controls

The PGV... reader is equipped with seven indicator LEDs for carrying out visual function checks and rapid diagnostics. The reader is equipped with two buttons at the back for activating the alignment aid and parameterization mode.

LEDs

LED	Color	Label	Meaning
1	green	BUS LINK	PROFINET communication active
2	yellow	BUS ACTIVITY	Connection status
4	red / green	PWR / ADJ SYSERR/NO CODE	Code detected/not detected, error
5	yellow	LANE AVAILABLE	Lane available
6	yellow	FOLLOW R/L	"Follow lane" activated
7	red/green/yellow	INTERNAL DIAGNOSTIC	Internal diagnostics

External Parameterization

In order to parameterize the device externally, the parameterization code is required in the form of a Data Matrix containing the desired reader parameters. Data Matrix code cards detailing the step-by-step process for externally parameterizing the device are printed in the operating instructions for the reader.

The reader can be parameterized only within ten minutes of being switched on. If a key is pressed after ten minutes of the device being switched on, a visual signal is given by the LEDs (LED1, green/LED2, red/LED4, green/LED5, yellow/LED6, yellow, flashing for two seconds).

- The switchover from normal mode to parameterization mode is made by pressing button 2 on the back of the reader. To switch the device over, button 2 must be pressed and held for more than two seconds. LED5 then flashes.

Note: Parameterization mode is exited automatically if the device is inactive for one minute. In this case, the reader reverts to normal mode and operates without the settings having been changed.
- Place the parameterization code in the field of vision of the camera module. After the parameterization code is detected, the green LED4 lights up for one second. In the event of an invalid parameterization code, LED4 lights up red for two seconds.
- Briefly pressing button 2 will end parameterization mode.