



## Retroreflective sensor OBR15M-R201-2EP-IO-0,3M-V15



- Medium design with versatile mounting options
- Extended temperature range  
-40 °C ... 60 °C
- High degree of protection IP69K
- IO-Link interface for service and process data

Retroreflective sensor with polarization filter



### Function

The optical sensors in the series are the first devices to offer an end-to-end solution in a medium-sized standard design – from the thru-beam sensor through to the measuring distance sensor. As a result of this design, the sensors are able to perform practically all standard automation tasks.

The entire series enables sensors to communicate via IO-Link.

The DuraBeam laser sensors are durable and can be used in the same way as a standard sensor.

Multi Pixel Technology (MPT) ensures that the standard sensors are flexible and can be adapted to the application environment.

## Dimensions

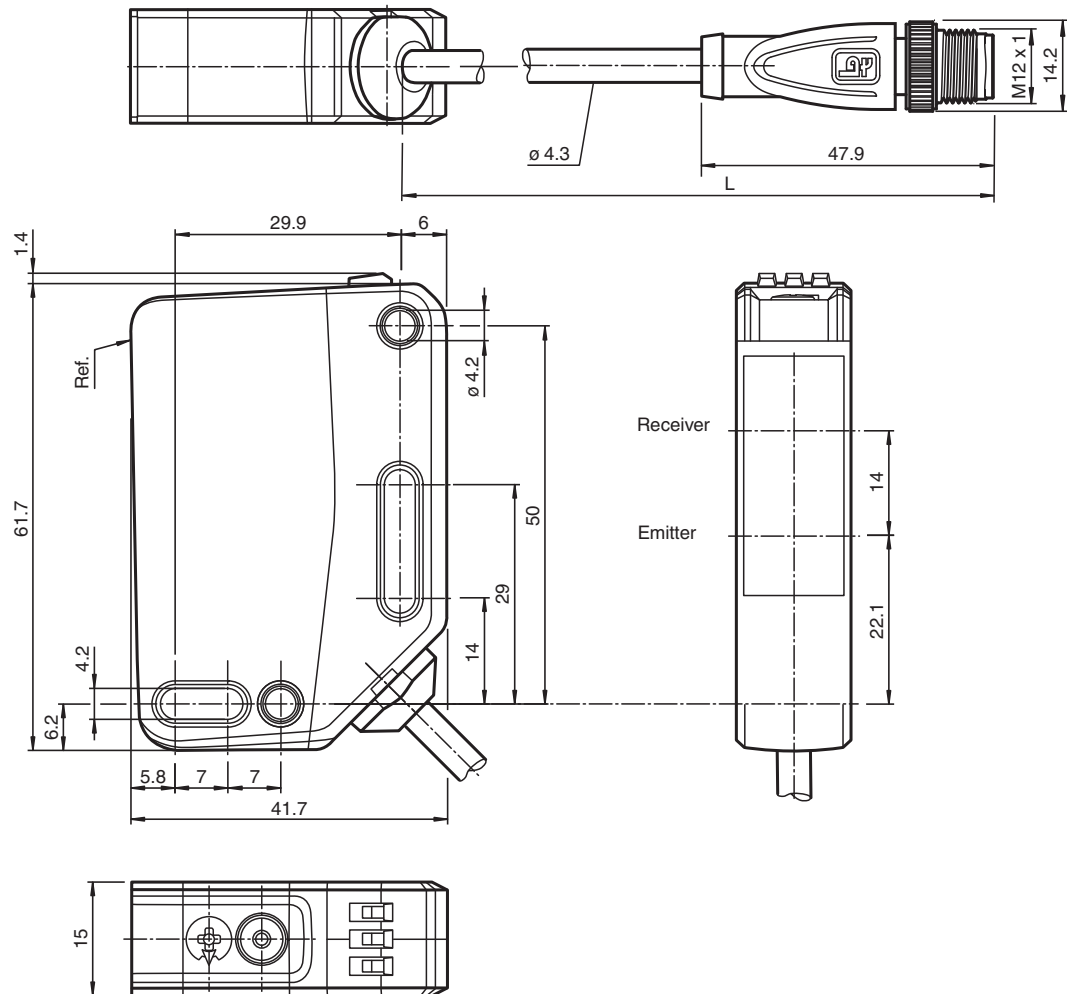

## Technical Data

### General specifications

Effective detection range	0 ... 15 m
Reflector distance	0.02 ... 15 m
Threshold detection range	18.5 m
Reference target	H85-2 reflector
Light source	LED
Light type	modulated visible red light
LED risk group labelling	exempt group
Polarization filter	yes
Diameter of the light spot	approx. 520 mm at a distance of 15 m
Opening angle	2 °
Ambient light limit	EN 60947-5-2 : 60000 Lux

### Functional safety related parameters

MTTF <sub>d</sub>	724 a
Mission Time (T <sub>M</sub> )	20 a
Diagnostic Coverage (DC)	60 %

### Indicators/operating means

Operation indicator	LED green: constantly on - power on flashing (4Hz) - short circuit flashing with short break (1 Hz) - IO-Link mode
---------------------	---

## Technical Data

Function indicator		Yellow LED: Permanently lit - light path clear Permanently off - object detected Flashing (4 Hz) - insufficient operating reserve
Control elements		Light-on/dark-on changeover switch
Control elements		sensitivity adjustment
<b>Electrical specifications</b>		
Operating voltage	$U_B$	10 ... 30 V DC
Ripple		max. 10 %
No-load supply current	$I_0$	< 18 mA at 24 V Operating voltage
Protection class		III
<b>Interface</b>		
Interface type		IO-Link ( via C/Q = pin 4 )
IO-Link revision		1.1
Device profile		Identification and diagnosis Smart Sensor type 2.4
Device ID		0x111213 (1118739)
Transfer rate		COM2 (38.4 kBit/s)
Min. cycle time		2.3 ms
Process data width		Process data input 2 Bit Process data output 2 Bit
SIO mode support		yes
Compatible master port type		A
<b>Input</b>		
Test input		emitter deactivation at $+U_B$
<b>Output</b>		
Switching type		The switching type of the sensor is adjustable. The default setting is: C/Q - Pin4: NPN normally open / dark-on, PNP normally closed / light-on, IO-Link /Q - Pin2: NPN normally closed / light-on, PNP normally open / dark-on
Signal output		2 push-pull (4 in 1) outputs, short-circuit protected, reverse polarity protected, overvoltage protected
Switching voltage		max. 30 V DC
Switching current		max. 100 mA , resistive load
Usage category		DC-12 and DC-13
Voltage drop	$U_d$	$\leq 1.5$ V DC
Switching frequency	$f$	1000 Hz
Response time		0.5 ms
<b>Conformity</b>		
Communication interface		IEC 61131-9
Product standard		EN 60947-5-2
<b>Approvals and certificates</b>		
UL approval		E87056 , cULus Listed , class 2 power supply , type rating 1
CCC approval		CCC approval / marking not required for products rated $\leq 36$ V
<b>Ambient conditions</b>		
Ambient temperature		-40 ... 60 °C (-40 ... 140 °F) , fixed cable -20 ... 60 °C (-4 ... 140 °F) , movable cable not appropriate for conveyor chains
Storage temperature		-40 ... 70 °C (-40 ... 158 °F)
<b>Mechanical specifications</b>		
Housing width		15 mm
Housing height		61.7 mm
Housing depth		41.7 mm
Degree of protection		IP67 / IP69 / IP69K
Connection		300 mm fixed cable with plug, M12 x 1, 5 pin
Material		
Housing		PC (Polycarbonate)
Optical face		PMMA

Release date: 2023-05-09 Date of issue: 2023-05-09 Filename: 295670-100068\_eng.pdf

## Technical Data

Mass	approx. 55 g
Cable length	0.3 m

## Connection

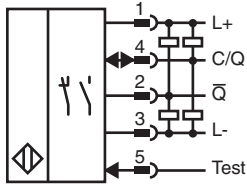

## Connection Assignment

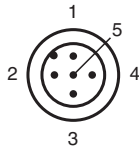

Wire colors in accordance with EN 60947-5-2

1	BN	(brown)
2	WH	(white)
3	BU	(blue)
4	BK	(black)
5	GY	(gray)

## Assembly

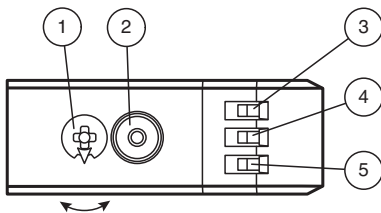

1	Sensitivity adjustment	
2	Light-on / dark-on changeover switch	
3	Operating indicator / dark on	GN
4	Signal indicator	YE
5	Operating indicator / light on	GN

Release date: 2023-05-09 Date of issue: 2023-05-09 Filename: 295670-100068\_eng.pdf

**Characteristic Curve**

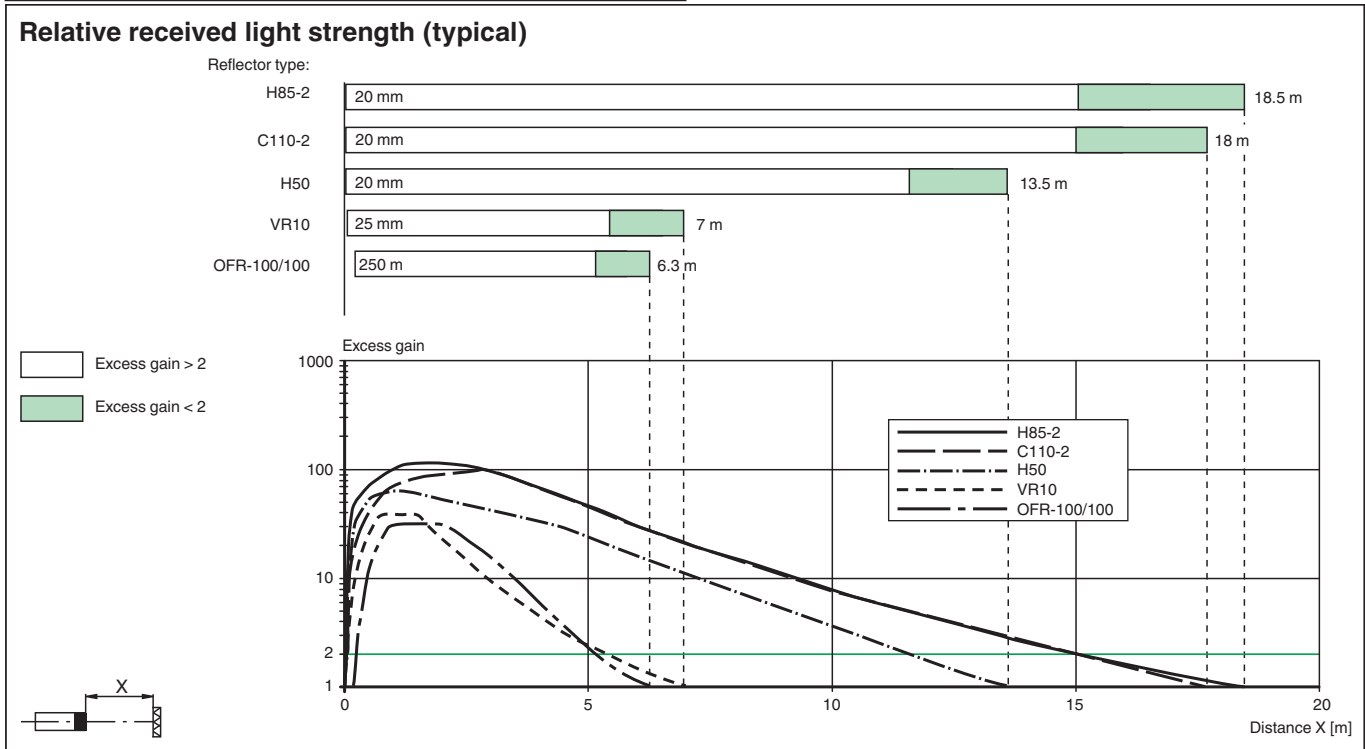
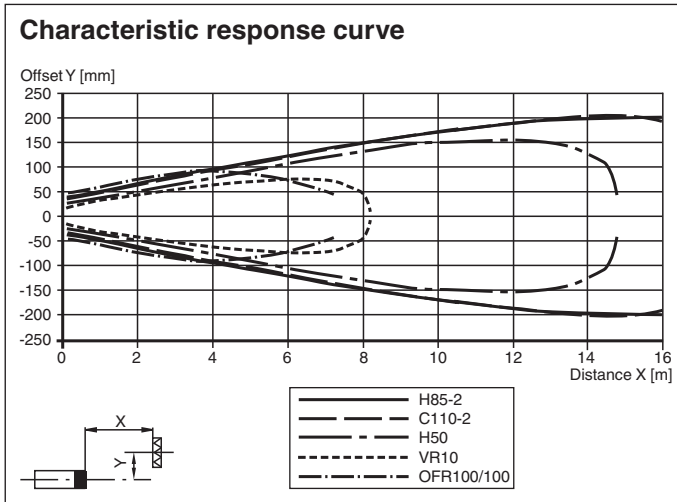

**Commissioning**

To unlock the adjustment functions turn the sensing range / sensitivity adjuster for more than 180 degrees.

**Sensing Range / Sensitivity**

Turn sensing range / sensitivity adjuster clockwise to increase sensing range / sensitivity.  
 Turn sensing range / sensitivity adjuster counter clockwise to decrease sensing range / sensitivity.  
 If the end of the adjustment range is reached, the signal indicator starts flashing with 8 Hz.

**Light-on / Dark-on Configuration**

Press the light-on / dark-on changeover switch for more than 1 second (less than 4 seconds). The light-on / dark-on mode changes and the operating indicators are activated accordingly.  
 If you press the light-on / dark-on changeover switch for more than 4 seconds, the light-on / dark-on mode changes back to the original setting. On release of the light-on / dark-on changeover switch the current state is activated.

**Restore Factory Settings**

Press the light-on / dark-on changeover switch for more than 10 seconds (less than 30 seconds) until all LEDs turn off. On release of the light-on / dark-on changeover switch the signal indicator turns on. After 5 seconds the sensor resumes operation with factory default settings.

After 5 minutes of inactivity the sensing range / sensitivity adjustment is locked. In order to reactivate the sensing range / sensitivity adjustment, turn the sensing range / sensitivity adjuster for more than 180 degrees.





















**Accessories**

	<b>V15-W-2M-PUR</b>	Female cordset single-ended M12 angled A-coded, 5-pin, PUR cable grey
--	---------------------	---



Release date: 2023-05-09 Date of issue: 2023-05-09 Filename: 295670-100068\_eng.pdf

Refer to "General Notes Relating to Pepperl+Fuchs Product Information".

## Accessories

	<b>V15-G-2M-PUR</b>	Female cordset single-ended M12 straight A-coded, 5-pin, PUR cable grey
	<b>REF-H85-2</b>	Reflector, rectangular 84.5 mm x 84.5 mm, mounting holes
	<b>REF-C110-2</b>	Reflector, round ø 84 mm, central mounting hole
	<b>REF-H50</b>	Reflector, rectangular 51 mm x 61 mm, mounting holes, fixing strap
	<b>REF-VR10</b>	Reflector, rectangular 60 mm x 19 mm, mounting holes
	<b>OFR-100/100</b>	Reflective tape 100 mm x 100 mm
	<b>V1-G-2M-PUR</b>	Female cordset single-ended M12 straight A-coded, 4-pin, PUR cable grey
	<b>V1-W-2M-PUR</b>	Female cordset single-ended M12 angled A-coded, 4-pin, PUR cable grey
	<b>OMH-RL31-02</b>	Mounting bracket narrow
	<b>OMH-RL31-03</b>	Mounting bracket narrow
	<b>OMH-RL31-04</b>	Mounting aid for round steel ø 12 mm or sheet 1.5 mm ... 3 mm
	<b>OMH-RL31-07</b>	Mounting bracket including adjustment
	<b>OMH-RL31-08</b>	Mounting aid for round steel ø 12 mm or sheet 1.5 mm ... 3 mm
	<b>OMH-R20x-Quick-Mount</b>	Quick mounting accessory
	<b>ICE2-8IOL-G65L-V1D</b>	EtherNet/IP IO-Link master with 8 inputs/outputs
	<b>ICE3-8IOL-G65L-V1D</b>	PROFINET IO IO-Link master with 8 inputs/outputs
	<b>ICE2-8IOL-K45S-RJ45</b>	EtherNet/IP IO-Link master with 8 inputs/outputs, DIN rail, screw terminal
	<b>ICE3-8IOL-K45P-RJ45</b>	PROFINET IO IO-Link master with 8 inputs/outputs, DIN rail, push-in terminals
	<b>ICE3-8IOL-K45S-RJ45</b>	PROFINET IO IO-Link master with 8 inputs/outputs, DIN rail, screw terminal
	<b>IO-Link-Master02-USB</b>	IO-Link master, supply via USB port or separate power supply, LED indicators, M12 plug for sensor connection

## Accessories

	<b>ICE1-8IOL-G30L-V1D</b>	Ethernet IO-Link module with 8 inputs/outputs
	<b>ICE1-8IOL-G60L-V1D</b>	Ethernet IO-Link module with 8 inputs/outputs
	<b>ICE2-8IOL-K45P-RJ45</b>	EtherNet/IP IO-Link master with 8 inputs/outputs, DIN rail, push-in connectors