



Vision Sensor

VOS2000-F226-C-S

- Wide range of detection tools for flexible inspection tasks
- Combinable vision tools for feature detection, completeness checking, code reading, text recognition and object position checking
- 32 Jobs on-board can be saved
- Exchangeable lens (C-Mount)
- Easy integration with flexible programmable data output

Vision sensor for advanced object detection; Resolution: 1280 x 960 pixels; Light source: external illumination; Lens: C-mount connection



Dimensions

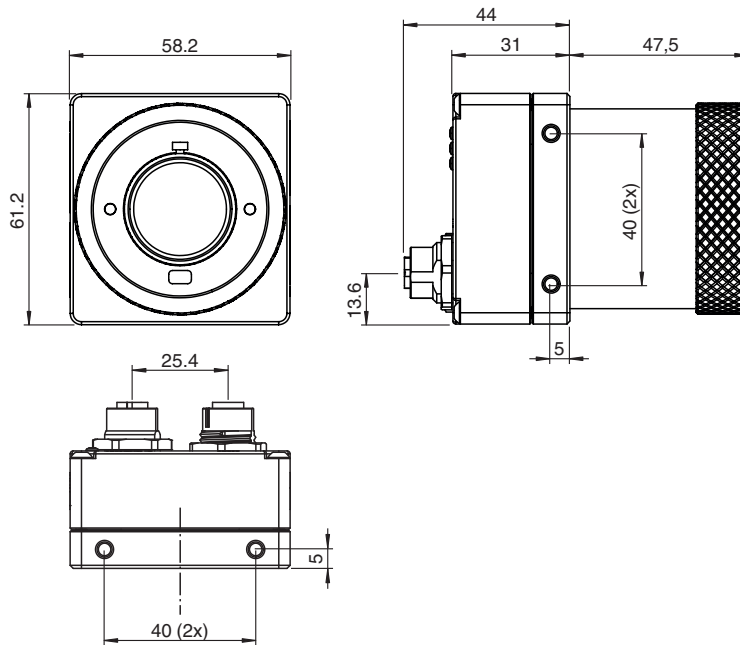

Technical Data

General specifications

Light source	External lighting
Picture detail	dependant of operating distance (see manual)
Trigger mode	Free-running or triggered externally
Depth of focus	± 5 % of the operating distance
Resolution	1280 x 960 pixels
Image sensor	1/3" CMOS monochrom Global Shutter 3.75 µm pixel size

Parameterization/software

Release date: 2022-11-28 Date of issue: 2022-11-28 Filename: 70114982_eng.pdf

Refer to "General Notes Relating to Pepperl+Fuchs Product Information".

Pepperl+Fuchs Group
www.pepperl-fuchs.com

USA: +1 330 486 0001
fa-info@us.pepperl-fuchs.com

Germany: +49 621 776 1111
fa-info@de.pepperl-fuchs.com

Singapore: +65 6779 9091
fa-info@sg.pepperl-fuchs.com

PEPPERL+FUCHS

Technical Data

Parameter assignment		Parameterization via PC user interface VCT Tool
Evaluation procedure		
Positioning and Guidance		Based on Parts or product marks, up to four Locators to detect X,Y shift and rotation
Identification and Verification		OCR, 1-D and 2-D codes
Detection & Pattern Matching		Pixel-, contour- or edge count
Measuring		Distance, angle, circle size (after calibration)
Indicators/operating means		
LED 1		Steady blue: sensor started, not set up Steady green: job loaded, ready for execution Flashing green: job loaded and being executed, capture in progress Steady red: sensor fault
LED 2		Flashing blue: starting (duration approx. 20 seconds) Steady green: measurement successful (Pass) Steady blue: measurement borderline (Recycle) Steady red: measurement unsuccessful (Fail)
LED 3		Steady blue: warm reset or restart Steady red/green/yellow: network activity
Electrical specifications		
Operating voltage	U_B	12 ... 30 V DC
No-load supply current	I_0	300 mA
Interface 1		
Interface type		Ethernet
Protocol		PROFINET IO TCP/IP EtherNet/IP
Transfer rate		100 MBit/s
Interface 2		
Interface type		RS-232 , serial
Transfer rate		115.2 kBit/s
Input		
Input type		optically decoupled Inputs
Input voltage		Logic low (OFF): 0 ... 3 V Logic high (ON): 11 ... 30 V Switching threshold: 12 V
Control input		Image capture trigger + 2 general purpose inputs 2 inputs can be used for job switching
Input current		8 mA (typical)
Internal protection circuit		3 k Ω / 4000 V (rms)
Switching delay		Switch-on time (ON): 20 μ s Switch-off time (OFF): 10 μ s Image capture trigger: 62 μ s (until image capture is triggered)
Output		
Output type		3 general purpose outputs , freely programmable , optically decoupled
Switching voltage		max. 30 V
Switching current		max. 100 mA each output
Switching delay		Switch-on time (ON): 150 μ s Switch-off time (OFF): 50 μ s
Standard conformity		
Emitted interference		EN 61000-6-4:2007+A1:2011
Noise immunity		EN 61000-6-2:2005
Approvals and certificates		
Approvals		CE
Ambient conditions		
Ambient temperature		0 ... 50 °C (32 ... 122 °F)
Storage temperature		-20 ... 60 °C (-4 ... 140 °F)
Mechanical specifications		
Housing length		61 mm
Housing width		58 mm
Housing height		57 mm

Release date: 2022-11-28 Date of issue: 2022-11-28 Filename: 70114982_eng.pdf

Refer to "General Notes Relating to Pepperl+Fuchs Product Information".

Pepperl+Fuchs Group
www.pepperl-fuchs.com

USA: +1 330 486 0001
fa-info@us.pepperl-fuchs.com

Germany: +49 621 776 1111
fa-info@de.pepperl-fuchs.com

Singapore: +65 6779 9091
fa-info@sg.pepperl-fuchs.com

 PEPPERL+FUCHS

Technical Data

Degree of protection	IP67 (with mounted lens protection cover)
Connection	8-pin M12 socket A-coded ; 12-pin M12 socket
Material	
Housing	anodized aluminum
Installation	Mounting bracket
Mass	approx. 200 g
Objective connection	C-mount connection for external lens with different focal lengths

Connection Assignment

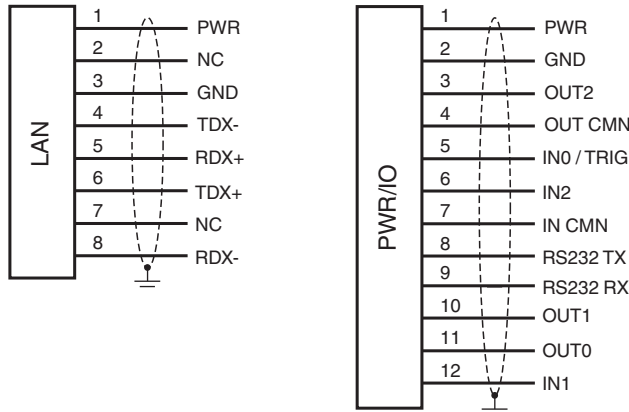

Connection

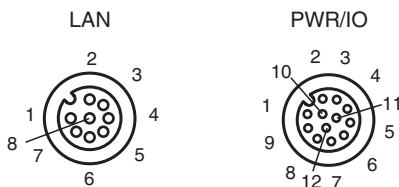















Accessories

	V19S-G-GN5M-PUR-ABG-V45-G	Ethernet bus cable M12 plug straight A-coded 8-pin to RJ45 plug straight 8-pin, PUR cable green, Cat6A, pairs shielded and overall shield, for connection of VOS cameras
	V112S-G-BK5M-PUR-ABG	Male cordset single-ended M12 straight A-coded, 12-pin, PUR cable black, shielded
	V112-G-BK3M-PUR-ABG-V112-G	Cordset M12 socket to M12 plug A-coded, 12-pin, PUR cable black, shielded
	VOS-LE-COV45	Protective cover
	VOS-MH01	Mounting aid for VOS sensors
	VOS-IL-F236W-10	Opening angle of the light beam: 10°, white light, 16 high-power LEDs, light field size: dia. 71 mm x 104 mm, integrated flash controller

Release date: 2022-11-28 Date of issue: 2022-11-28 Filename: 70114982_eng.pdf

Accessories

	VOS-IL-F236W-49	Opening angle of the light beam: 49°, white light, 16 high-power LEDs, light field size: dia. 71 mm x 104 mm, integrated flash controller
	VOS-IL-F237W-44	Opening angle of the light beam: 44°, white light, 24 high-power LEDs, light field size: 242 x 18 mm, integrated flash controller
	VOS-IL-F237W-4819	Opening angle of the light beam: 48°x19°, white light, 16 high-power LEDs, light field size: 242 x 18 mm, integrated flash controller
	VOS-IL-F238W-10	Opening angle of the light beam: 10°, white light, 1 high-power LED, light field size: dia. 24.2 mm, integrated flash controller
	VOS-IL-F238W-26	Opening angle of the light beam: 26°, white light, 1 high-power LED, light field size: dia. 24.2 mm, integrated flash controller
	VOS-IL-F239W	White light, 576 high-power LEDs, diffused light, can be used as back lighting, light field size: 200 x 200 mm, integrated flash controller
	VOS-IL-F238W-49	Opening angle of the light beam: 49°, white light, 1 high-power LED, light field size: dia. 24.2 mm, integrated flash controller
	VOS-LE-C-8MM-JC	Fixed focal length lens with locking screws for C-mount cameras
	VOS-LE-C-6MM-JC	Fixed focal length lens with locking screws for C-mount cameras
	VOS-LE-C-50MM-JC	Fixed focal length lens, high-resolution, compact Megapixel lens, with locking screws for C-mount cameras
	VOS-LE-C-35MM-JC	Fixed focal length lens, high-resolution, compact Megapixel lens, with locking screws for C-mount cameras
	VOS-LE-C-25MM-JC	Fixed focal length lens, high-resolution, compact Megapixel lens, with locking screws for C-mount cameras
	VOS-LE-C-16MM-JC	Fixed focal length lens, high-resolution, compact Megapixel lens, with locking screws for C-mount cameras
	VOS-LE-C-12MM-JC	Fixed focal length lens, high-resolution, compact Megapixel lens, with locking screws for C-mount cameras