



Reflex ultrasonic sensor UBR250-F77-E3-V31

- Miniature design
- Program input
- Degree of protection IP67
- Switching status indicator, yellow LED

Reflex ultrasonic sensor



Function

The ultrasonic sensor works like a retroreflective sensor. It transmits ultrasonic packages in quick succession and responds to their reflection off a reference object at a defined distance. The distance T to the reference object can be taught in. The sensor has a switching output. The output switches when the sensor either no longer receives the echo from its reflector or no longer receives it as the first echo.

Dimensions

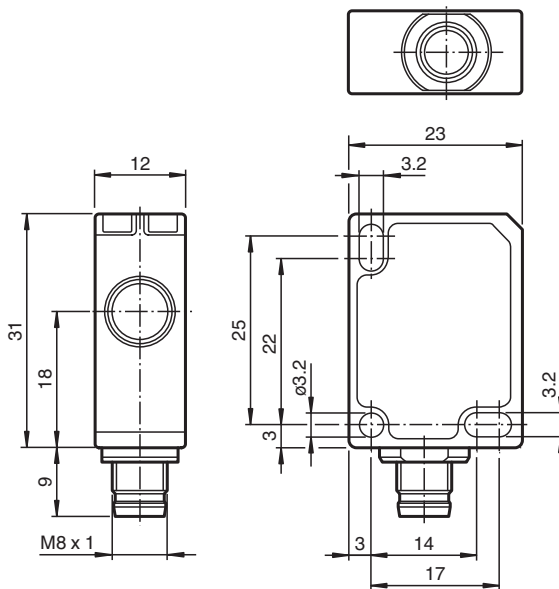

Technical Data

General specifications

Sensing range	0 ... 250 mm
Adjustment range	53 ... 250 mm
Standard target plate	20 mm x 20 mm
Transducer frequency	approx. 400 kHz

Release date: 2023-02-16 Date of issue: 2023-02-16 Filename: 233262_eng.pdf

Refer to "General Notes Relating to Pepperl+Fuchs Product Information".

Pepperl+Fuchs Group
www.pepperl-fuchs.com

USA: +1 330 486 0001
fa-info@us.pepperl-fuchs.com

Germany: +49 621 776 1111
fa-info@de.pepperl-fuchs.com

Singapore: +65 6779 9091
fa-info@sg.pepperl-fuchs.com

PF PEPPERL+FUCHS

Technical Data

Response delay	≤ 50 ms	
Limit data		
Permissible cable length	max. 300 m	
Indicators/operating means		
LED yellow	switching state and flashing: Teach-In	
Electrical specifications		
Rated operating voltage	U_e	24 V DC
Operating voltage	U_B	20 ... 30 V DC , ripple 10 % _{SS} ; 12 ... 20 V DC sensitivity reduced to 90 %
No-load supply current	I_0	≤ 20 mA
Time delay before availability	t_v	≤ 150 ms
Input		
Input type	1 program input	
Level	low level : 0 ... 0.7 V (Teach-In active) high level : U_B or open input (Teach-In inactive)	
Input impedance	16 kΩ	
Pulse length	≥ 3 s	
Output		
Output type	1 switch output PNP , NC contact	
Rated operating current	I_e	200 mA , short-circuit/overload protected
Voltage drop	U_d	≤ 2 V
Switching frequency	f	10 Hz
Off-state current	I_r	≤ 0.01 mA
Temperature influence	0.17 %/K	
Compliance with standards and directives		
Standard conformity		
Standards	EN IEC 60947-5-2:2020 IEC 60947-5-2:2019	
Approvals and certificates		
UL approval	cULus Listed, Class 2 Power Source	
CCC approval	CCC approval / marking not required for products rated ≤36 V	
Ambient conditions		
Ambient temperature	-25 ... 70 °C (-13 ... 158 °F)	
Storage temperature	-40 ... 85 °C (-40 ... 185 °F)	
Shock resistance	30 g , 11 ms period	
Vibration resistance	10 ... 55 Hz , Amplitude ± 1 mm	
Mechanical specifications		
Connection type	M8 x 1 connector , 4-pin	
Degree of protection	IP67	
Material		
Housing	Polycarbonate	
Transducer	epoxy resin/hollow glass sphere mixture; polyurethane foam	
Installation position	any position	
Mass	10 g	
Tightening torque, fastening screws	max. 0.2 Nm	
Factory settings		
Output	reflector distance 250 mm	

Connection

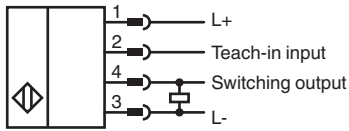

Connection Assignment



Wire colors in accordance with EN 60947-5-2

1	BN	(brown)
2	WH	(white)
3	BU	(blue)
4	BK	(black)

Characteristic Curve

Characteristic response curve

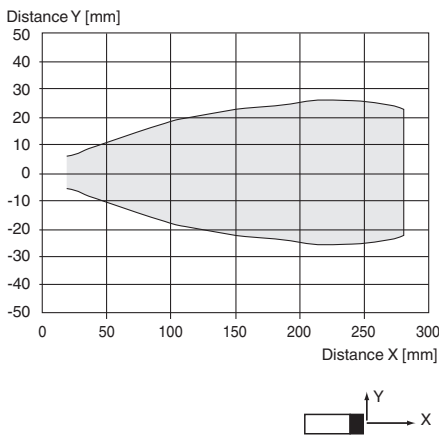

Commissioning

Adjustment Possibilities

The sensor is equipped with a switching output and operates exclusively in retro-reflective mode. A fixed machine part (plate, conveyor belt....), a wall or the floor is used as a reference object (reflector) and taught-in via the teach-in input of the sensor. The output of the sensor switches when the sensor either no longer receives the echo from its reflector or no longer receives it as the first echo:

- The first case occurs when there is a sufficiently large, angled or highly sound-absorbing object between the sensor and the reflector.
- The second case occurs when there is an object between the sensor and the reflector that reflects an echo to the sensor. In this case, the object may also be smaller than the reflector.





When teaching-in the reflector distance, the sensor automatically generates a switching window in the range of the taught-in reflector distance +/- 5%. The distance of the reference object (reflector) must not change during operation. Any modifications to the reference object distance require a new teach-in.

Further Documentation

For information on programming via teach-in input you may refer to the commissioning instruction.

Release date: 2023-02-16 Date of issue: 2023-02-16 Filename: 233262_eng.pdf

Accessories

	UB-PROG4-V31	Programming unit for ultrasonic sensors with Teach-in input at pin 2
	OMH-ML7-01	Mounting aid for ML7 and ML8 series, Mounting bracket
	V31-GM-2M-PVC	Female cordset single-ended M8 straight A-coded, 4-pin, PVC cable grey
	V31-WM-2M-PVC	Female cordset single-ended M8 angled A-coded, 4-pin, PVC cable grey