



Model Number

OMH-11-06 Aperture-V-H 1.5 mm

Slit diaphragm can be affixed for detecting very small parts

Features

- Slit aperture to shape the light in miniature sensors
- Facilitates the detection of very small parts
- Min. object size 1.5 mm
- Self-adhesive mounting

Dimensions

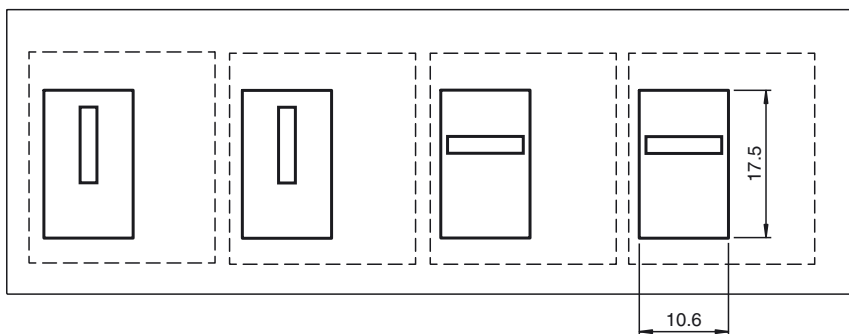

Technical data

General specifications

Slot width	1.5 mm
Object size	min. 1.5 mm

Ambient conditions

Ambient temperature	-40 ... 75 °C (-40 ... 167 °F)
Storage temperature	< 35 °C
Installation temperature	4 ... 35 °C (39.2 ... 95 °F)

Environmental resistance	UV radiation Humidity Salt spray (240 h / 5%) fungus-resistant
--------------------------	---

Chemical resistance	Oils Grease Fuels Aliphatic solvents Weak acids
---------------------	---

Mechanical specifications

Material thickness	0.07 ... 0.1 mm
Material	molded PVC film
Mass	approx. 0.8 g
Dimensions	17.5 mm x 10.6 mm
Mounting	self-adhesive
Adhesive	Acrylate-based adhesive , transparent

Suitable series

Series	ML4.2 ML6
--------	--------------

Aperture alignment

When attaching the aperture, make sure that the sensor lens is aligned exactly with the black aperture.

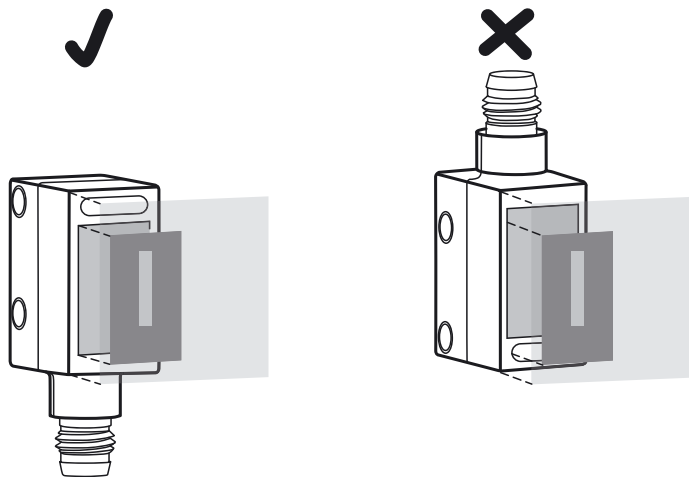

Accessories**ML4.2-54-G/40b/110/115**

Retroreflective sensor for clear object detection

ML4.2-54-G/40b/95/110

Retroreflective sensor for clear object detection

ML6-54-F/110/115a

Retroreflective sensor with polarization filter

ML6-54-F/25/115/136

Retroreflective sensor with polarization filter

ML6-54-F/25/95/136

Retroreflective sensor with polarization filter

ML6-54-F/82b/95/110

Retroreflective sensor with polarization filter

ML6-54-G/25/115/136

Retroreflective sensor with polarization filter for clear object detection

ML6-54-G/25/95/136

Retroreflective sensor with polarization filter for clear object detection

ML4.2-54-F/40b/103/115b

Retroreflective sensor with polarization filter

ML4.2-54-F/40b/110/115

Retroreflective sensor with polarization filter

ML4.2-54-F/40b/110/115b

Retroreflective sensor with polarization filter

ML4.2-54-F/40b/95/103

Retroreflective sensor with polarization filter

ML4.2-54-F/40b/95/110

Retroreflective sensor with polarization filter

ML4.2-54-F/95/110/126b

Retroreflective sensor with polarization filter

M6/MV6-8000-RT/25/76a/115/136

Thru-beam sensor

M6/MV6-8000-RT/25/76a/95/136

Thru-beam sensor

M4.2/MV4.2-4000-LAS/76a/95/110

Thru-beam sensor

M4.2/MV4.2-8000-RT/76a/110/115

Thru-beam sensor

M4.2/MV4.2-8000-RT/76a/95/110

Thru-beam sensor