

Connection cable

V1-W-E8-BK0,6M-PUR-A-V1-G



- Improved resistance to weld spatter
- Suitable for drag chains and abrasion resistant
- Suitable for robotic applications / torsion resistant
- Built-in LED, as operating and function indicator
- Degree of protection IP68 / IP69
- Free of paint wetting interfering substances
- Resistant to microbes and hydrolysis
- UL listed for USA and Canada
- Halogen-free
- Specific design protects against loosening and inaccurate installation

Cordset M12 socket angled A-coded LED 4-pin to M12 plug straight A-coded 4-pin, PUR cable weld spatter resistant black, UL approved, drag chain suitable, torsion resistant



Dimensions

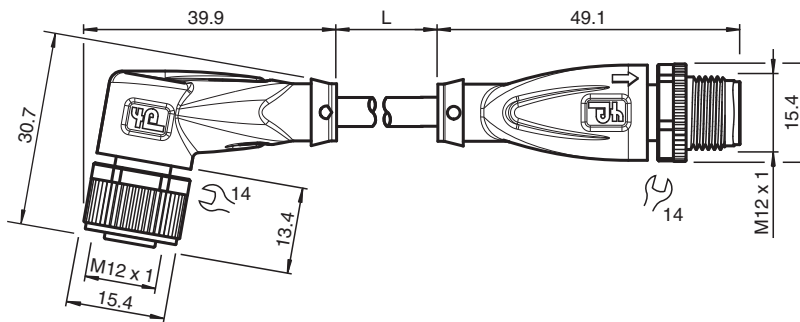

Technical Data

General specifications

Connector 1	
Connection	socket
Construction type	M12
Style	angled
Locking	screw connection
Number of pins	4
Coding	A-coded
Connector 2	
Connection	plug
Construction type	M12
Style	straight
Locking	screw connection
Number of pins	4
Coding	A-coded

Release date: 2022-11-30 Date of issue: 2022-11-30 Filename: 240784-100017_eng.pdf

Refer to "General Notes Relating to Pepperl+Fuchs Product Information".

Pepperl+Fuchs Group
www.pepperl-fuchs.com

USA: +1 330 486 0001
fa-info@us.pepperl-fuchs.com

Germany: +49 621 776 1111
fa-info@de.pepperl-fuchs.com

Singapore: +65 6779 9091
fa-info@sg.pepperl-fuchs.com

PF PEPPERL+FUCHS

Technical Data

Indicators/operating means		
LED green		Operating display
LED yellow		Functional display pin 4
LED red		Functional display pin 2
Electrical specifications		
Operating voltage	U _B	max. 24 V DC -20 % / +25 %
Operating current	I _B	max. 4 A
Conformity		
Degree of protection		EN 60529
Plug connection		connector M12 x 1 : IEC 61076-2-101
Flammability		UL 1581; DIN EN 60332-2-2
Halogen-free		DIN VDE 0472-815 IEC 60754-1
Microbial resistance		DIN EN 50525-2-21 / DIN VDE 0282-10
Hydrolysis resistance		DIN EN 50525-2-21
Approvals and certificates		
UL approval		AWM STYLE 20549 AWM I/II A/B 80°C 300V FT2 (cable)
UL File Number		E231213
Ambient conditions		
Ambient temperature		
Plug connector		-40 ... 90 °C (-40 ... 194 °F)
Cable, fixed		-40 ... 80 °C (-40 ... 176 °F)
Cable, flexing		-25 ... 80 °C (-13 ... 176 °F)
Pollution degree		3
Mechanical specifications		
Plug connector		
Tightening torque		0.6 Nm
Loosening protection		available
Tool installation		straight knurling and hexagon nut SW = 14 mm
Mating cycles		min. 100
Degree of protection		IP68 / IP69
Cable		according to IEC/EN 60228 (DIN VDE 0295) class 6
Sheath diameter		4.3 mm
Bending radius		> 10 x cable diameter, moving > 5 x cable diameter, fixed
Sheath stripping force		max. 80 N / 300 mm
Sheath color		black (similar to RAL 9005)
Number of cores		4
Core cross section		0.34 mm ²
Cores color		Core 1: brown Core 2: white Core 3: blue Core 4: black
Core construction		42 x 0.1 mm Ø
Length	L	0.6 m
Cable code		Li F 9Y 11Y 4 x 0,34
Drag chain suitability		
Drag chain cycles		min. 5000000
Motion velocity		max. 3.3 m/s
Traverse distance		max. 5 m
Acceleration		max. 5 m/s ²
Torsion cycles		min. 1000000
Torsional stress		± 180 °/m
Material		
PWIS free		yes

Release date: 2022-11-30 Date of issue: 2022-11-30 Filename: 240784-100017_eng.pdf

Refer to "General Notes Relating to Pepperl+Fuchs Product Information".

 Pepperl+Fuchs Group
www.pepperl-fuchs.com

 USA: +1 330 486 0001
fa-info@us.pepperl-fuchs.com

 Germany: +49 621 776 1111
fa-info@de.pepperl-fuchs.com

 Singapore: +65 6779 9091
fa-info@sg.pepperl-fuchs.com

 **PEPPERL+FUCHS**





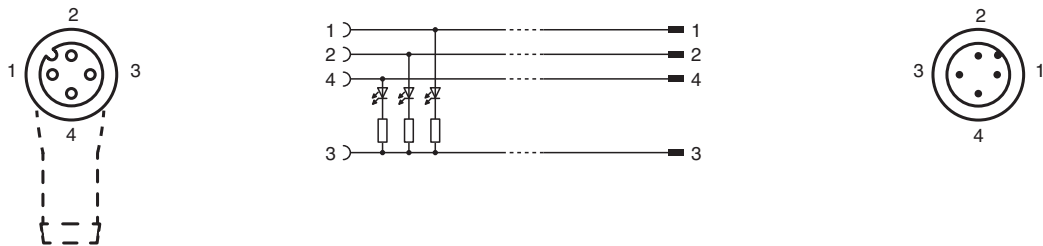

Technical Data

Halogen-free	yes
Plug connector	
Screw connection	Zinc diecast, nickel-plated
Body	TPU, transparent/black
Seal	FKM
Contact surface	gold plated (Au)
Flammability	V-2
Cable	
Sheathing	PUR based on polyether
Core insulation	PP
Weld spatter resistance	yes
Chemical resistance	good
Oil resistance	yes
Cooling lubricant resistance	yes
Microbial resistance	yes
Hydrolysis resistance	yes
Flammability	FT2

Connection Assignment



Accessories

	MH V1-SCREWDRIVER	Torque screwdriver (0.6 Nm)
	MH V1-BIT M12	plug-in cap M12
	V1/V3-LABELHOLDER	Label holder
	V1/V3-LABEL	Label plate
	MH V1-Holder	Modular universal holder for M12 connectors
	V1-CLIP	Unlocking protector for M12 connector
	V1-MARKING-RING-COLOR	Marking rings for M12 connectors, various colors

Release date: 2022-11-30 Date of issue: 2022-11-30 Filename: 240784-100017_eng.pdf